

The study of changes of the shape of the light pulses in strips of polymer scintillators

Monika Pawlik-Niedźwiecka

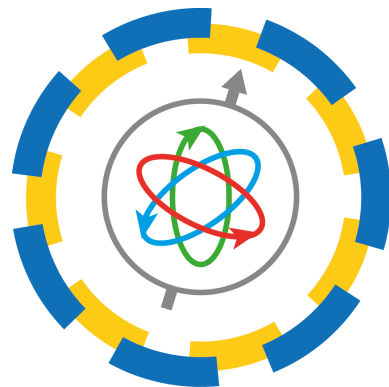

J-PET

Positron Emission Tomography

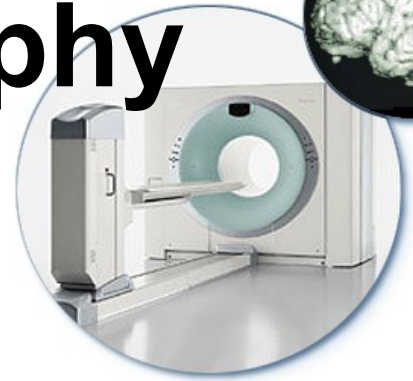
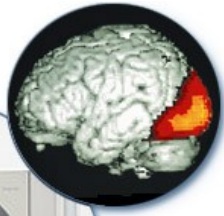

• **Positron emission tomography (PET)** is a **nuclear imaging technique** that uses the unique decay characteristics of radionuclides that **decay by positron emission**. When the radioactive atom on a particular molecule decays, a positron is ejected from the nucleus, ultimately leading to the emission of high-energy photons that have a good probability of escaping from the body.

• A PET scanner consists of a **set of detectors** that **surround the object** to be imaged and are designed to **convert these high-energy gamma quanta into an electrical signal** that can be fed to subsequent electronics.

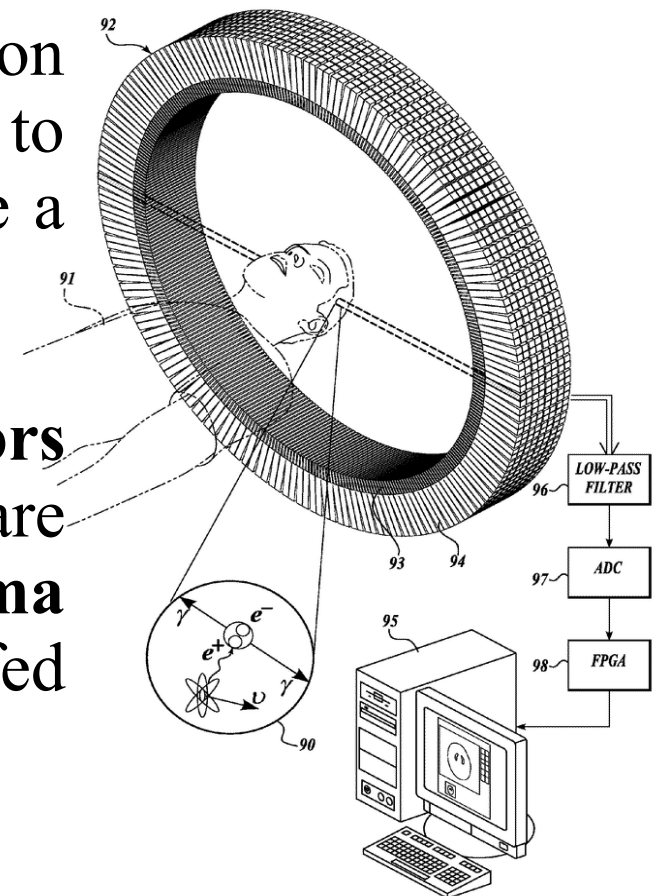

Short story about PET

- **1951** - Massachusetts General Hospital - first medical applications for the positron - **William H. Sweet** et al. developed and built the first brain probe using two opposing Sodium Iodide (NaI(Tl)) detectors,
- **Early 1960's** - **Kuhl and Edwards** - the earliest pioneers to develop image reconstruction techniques for single photon tomography (the principle of superimposition of back projections).



http://www.stricklandscanner.org.uk/pro_pet_history.html

Short story about PET

- **1973** - **James Robertson** built the first ring tomograph, **Michael E. Phelps** built the first PET tomograph (PET I),
- **1974** - **Mike Phelps** and **Ed Hoffman** constructed PET III – first human PET tomograph,
- **1980's** - technological advances in the 1980s allowed for the invention of PET scanners with higher resolution,
- **1977 – 1978** - discovery of **BGO** scintillator,
- **1978 – 1980** - **FDG** synthesized.

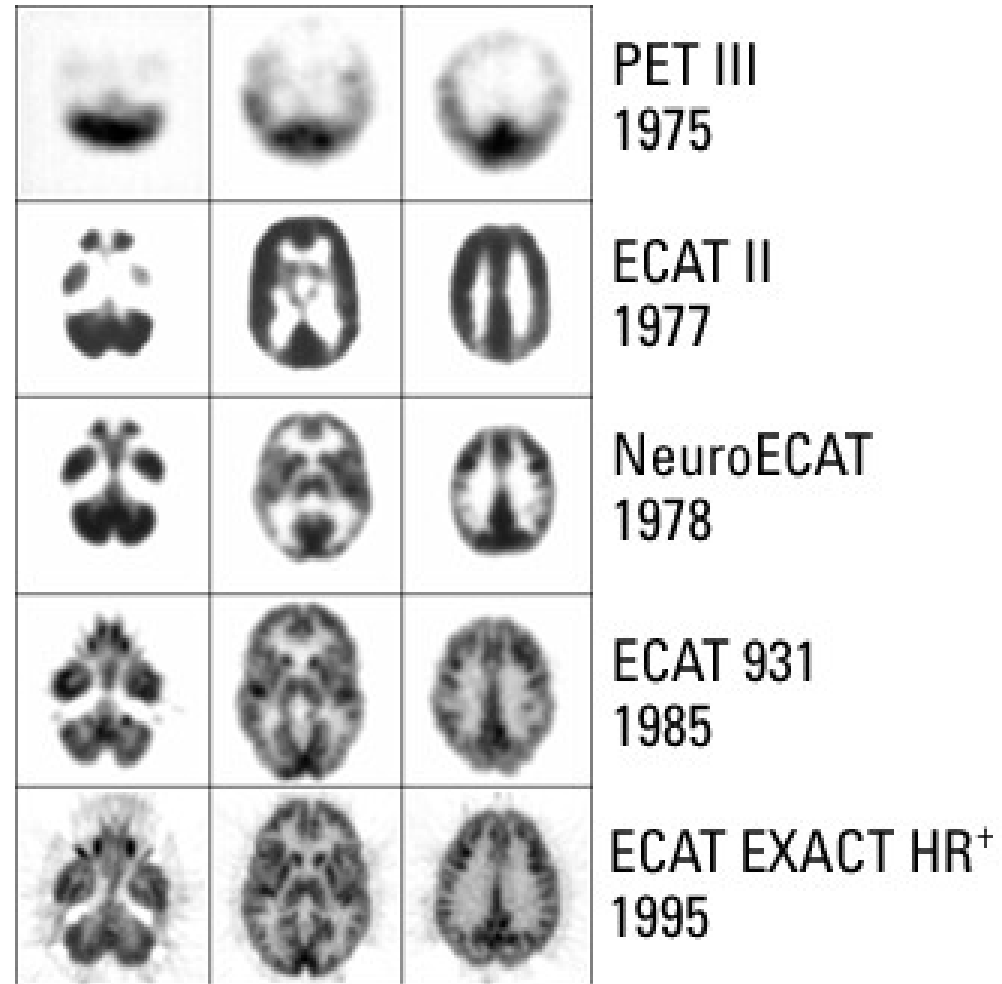

http://chemwiki.ucdavis.edu/Physical_Chemistry/Nuclear_Chemistry/Case_Studies/Radiation_in_Biology_and_Medicine/Case_Study%3A_Positron_Emission_Tomography

Short story about PET

- **1984 – 1985** – The **first block detector** had 32 crystals for four photomultipliers or 8 crystals per photomultiplier,
- **1989 - 1992** - discovery of **LSO** scintillator,
- **1999** – the **first human LSO** tomograph was delivered to the Max Planck Institute, Köln, Germany,
- **2000** - a combination LSO and NaI(Tl) **tomograph for PET and SPECT** was delivered to the Free University of Amsterdam.



http://www.cerebromente.org.br/n01/pet/pet_hist.htm

Basics of PET

The positron coming from β^+ decay has a very short lifetime in tissue, because it quickly loses energy by **electromagnetic reaction** with **electrons** and combines with one of them to form positronium. After 10^{-10} s **annihilation process** occurs. Mass of the electron and the positron is converted into **electromagnetic energy**.

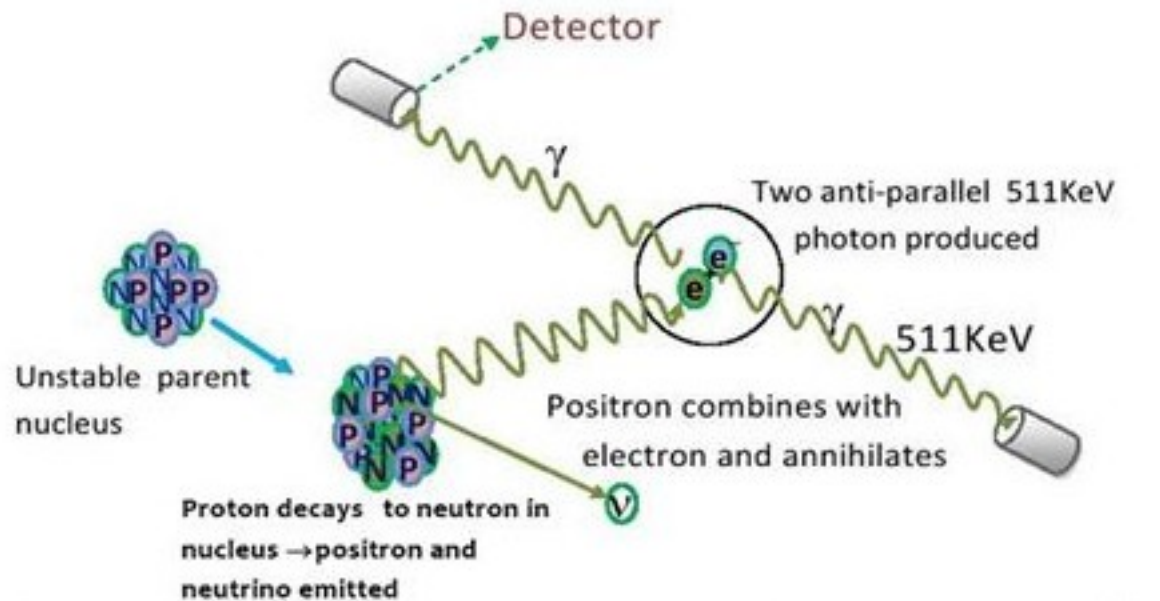
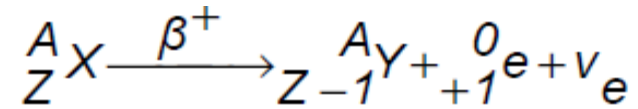

<http://www.assignmentpoint.com/wp-content/uploads/2013/12/Detector.jpg>

Radiopharmaceuticals

- markers for the diagnosis of cancer diseases mainly,
- substances used daily by organism (e.g. glucose) or their analogs,
- it is possible to visualize and locate anomalies at the level of a cell or group of cells, even if the anatomical organ piece is no different from the surrounding tissue,
- consists of

ligand + radioisotope

<http://www.euromedic.pl/pet-ct/dla-pacjent%C3%B3w/informacje-dla-pacjent%C3%B3w.aspx>



<http://www.lablogic.com/images%5CNewsItems%5CPET%5CPETraLabel.jpg>

Radiopharmaceuticals

- **ligand** - chemical compound that interacts with the body (captured in tissue, metabolized or participates in its physiological processes, e.g. FDG),
- **Radioisotope** - allows to image this process inside body:
 - positron emitters - used mainly in PET, e.g. ^{18}F , ^{82}Rb , ^{11}C , ^{15}O , and ^{13}N ,
 - single-photon emitters - used in SPECT, e.g. $^{99\text{m}}\text{Tc}$, ^{201}Tl , ^{123}I , ^{131}I , ^{111}In , and ^{67}Ga .

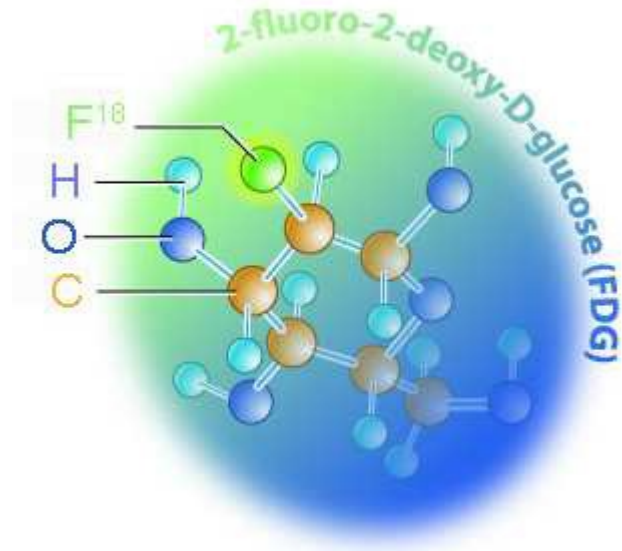

Radiopharmaceuticals

Values of the Half-Life of Some Commonly Used Radioisotopes

Isotope	Half-Life ($t_{1/2}$)
^{11}C	20.4 min
^{13}N	9.96 min
^{15}O	124 s
^{18}F	110 min
^{67}Ga	78.3 h
^{82}Rb	1.25 min
$^{99\text{m}}\text{Tc}$	6.02 h
^{111}In	2.83 days
^{123}I	13.2 h
^{131}I	8.02 days
^{201}Tl	73.1 h



Clinical PET Radiopharmaceuticals and Their Applications

PET Radiopharmaceutical	Application
^{18}F FDG	<p>Characterization, diagnosis, staging, and restaging of many forms of cancer</p> <p>Solitary pulmonary nodule assessment</p> <p>Epilepsy (refractory seizures)</p> <p>Myocardial perfusion or viability assessment</p>

Radiopharmaceuticals

- to get the necessary amount of radiopharmaceuticals, synthesis must be initiated with a considerable excess of the radioactive substrate, its duration therefore must be comparable to or longer than the radioisotopes half-time,
- the most commonly used isotope is ^{18}F due to the longest half-life (110 min),
- ^{18}F -FDG - a glucose analog, with the positron-emitting radioactive isotope fluorine-18 substituted for the normal hydroxyl group at the 2' position in the glucose molecule,

FDG is absorbed by all tissues of the body.

Comparison: Structures of FDG and Glucose

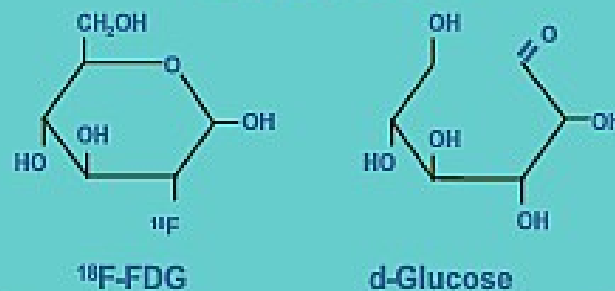

<http://www.rsc.org/learn-chemistry/resource/rws00396785/fludeoxyglucose-18f>

<http://www.nucmedtutorials.com/dwpetradiopharm/images/glucose.gif>

PET scanner

- several **thousand detector system** arranged **in ring** to measure **gamma quanta in coincidence**,
- **single block detector** consists of photomultipliers and partially cutted **crystal scintillator**,
- **cuts** ensure **linear division of scintillation light** between four photomultipliers,
- **X and Y coordinates of hit position** of annihilation quanta can be determined from signal from photomultiplier height.

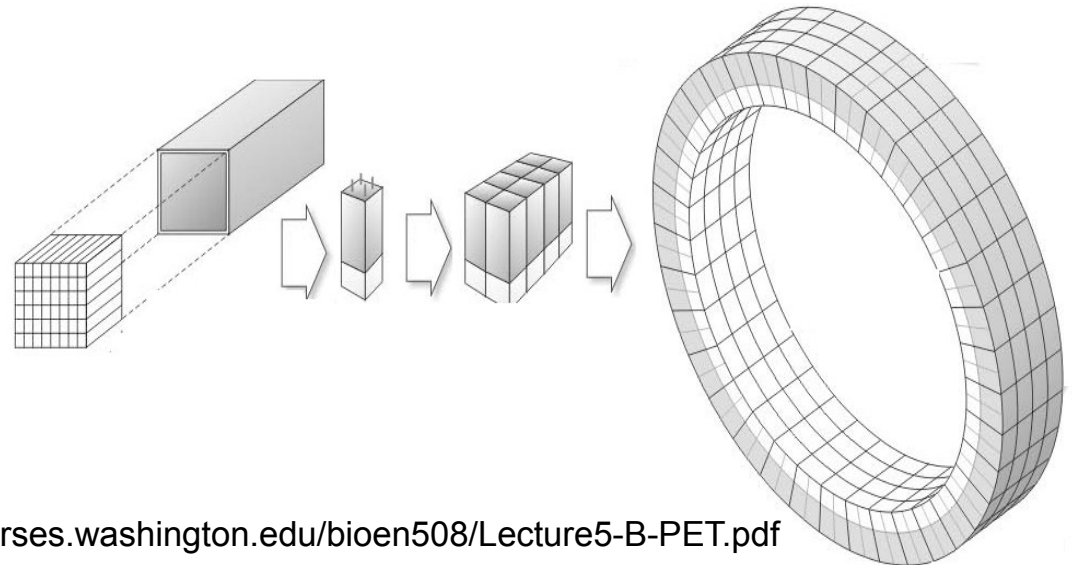
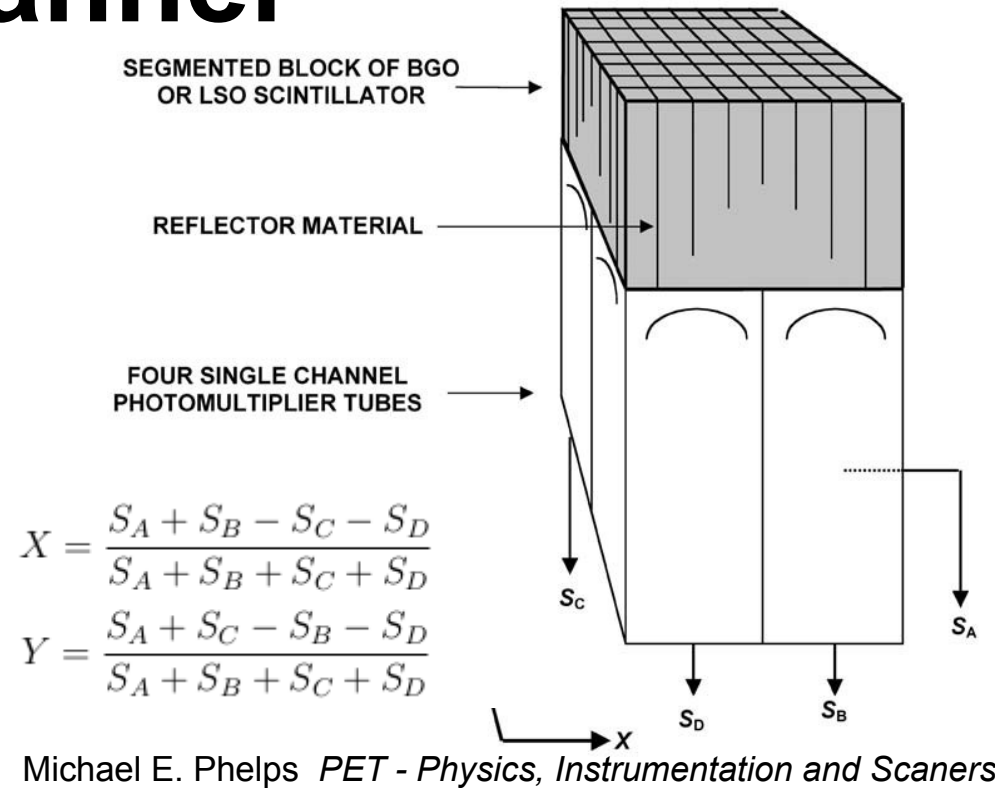

PET scanner - scintillators

- **scintillation process**

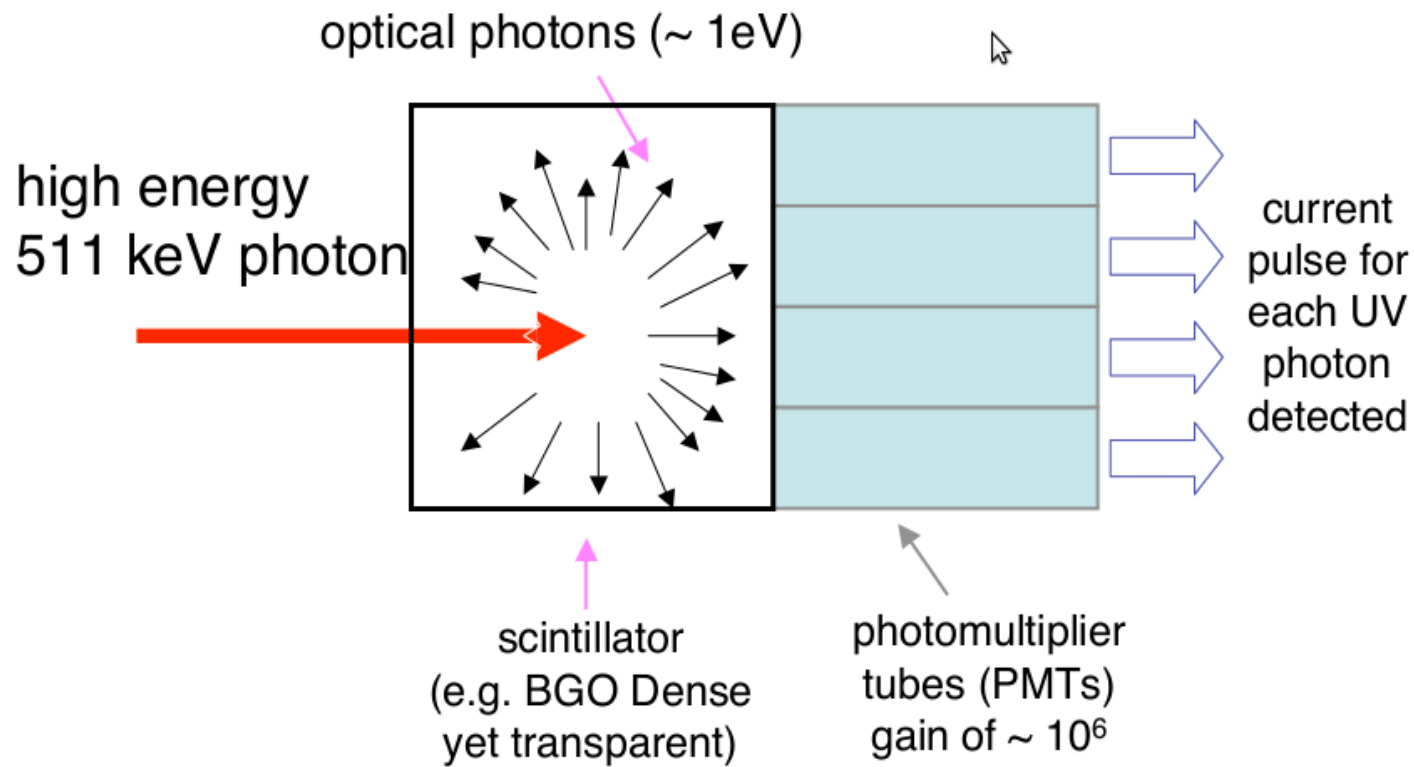

PET scanner - scintillators

- two types of scintillators :
 - **inorganic,**
 - **organic,**
- significant parameters:
 - light output - photons/keV deposited energy,
 - decay time - as short as possible,
 - very good energy resolution,
 - high density = higher probability of interaction of photons with electrons inside scintillators,
 - nonhydroscopic.

PET scanner - scintillators

- two types of scintillators :
 - **inorganic (crystal scintillators)** – high atomic number, good properties, scintillation mechanism based on the energy states, very expensive,

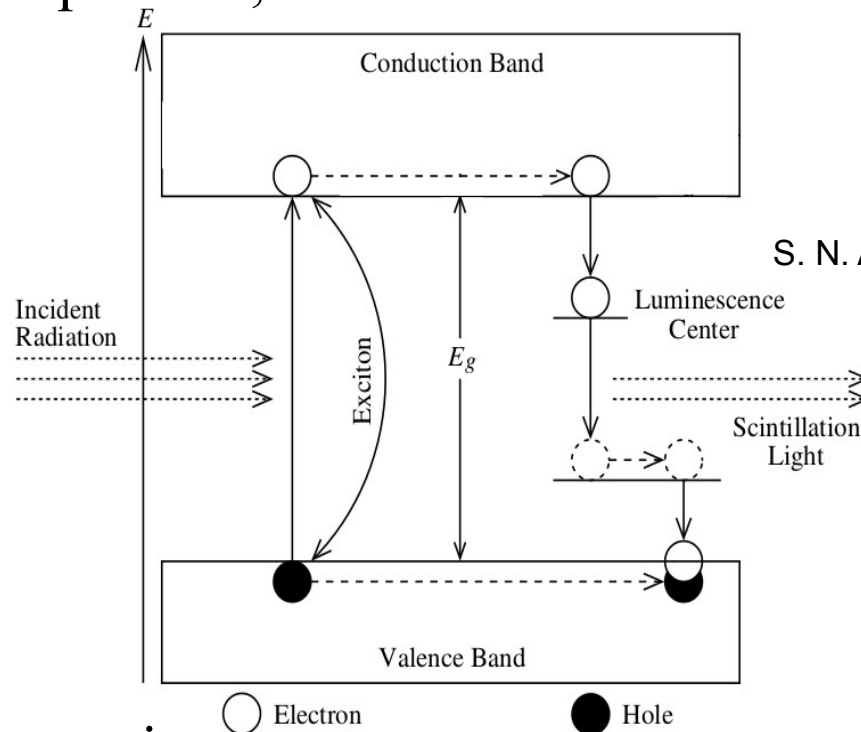

S. N. Ahmed *Physics and engineering of radiation detection*

- organic.

PET scanner - scintillators

- two types of scintillators :
 - inorganic,
 - **organic** - solid, gaseous and liquid form (e.g. **polymer scintillators**), many geometric shapes, scintillation mechanism based on fluorescence in single molecule.

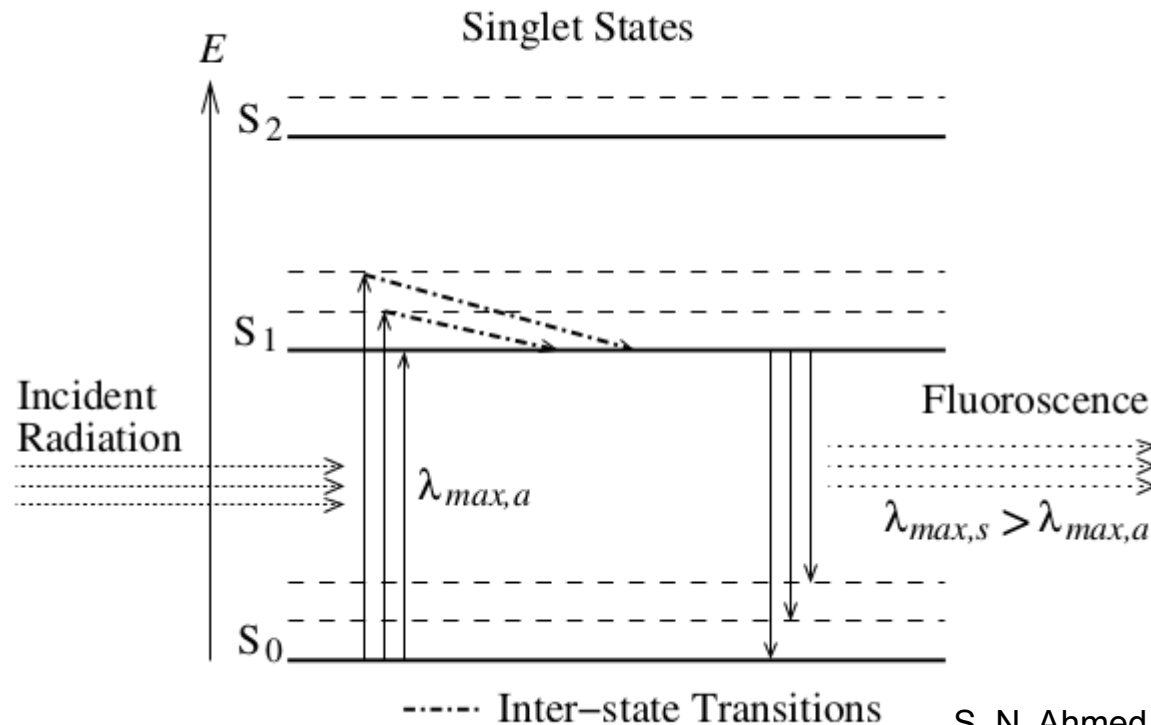

PET scanner - scintillators

name	type	density [g/cm³]	decay time [ns]	photons/ MeV
BGO	crystal	7.13	300	6000
GSO	crystal	6.71	50	10000
LSO	crystal	7.40	40	29000
NE102A	polymer	1.032	2.4	10000
BC404	polymer	1.032	1.8	10000
RP422	polymer	1.032	1.6	10000

P. Moskal *A novel TOF-PET detector based on organic scintillators*, International Conference on Translational Research in Radiation Oncology, Geneva, 10-14 February 2014

PET scanner – coincidence detection

A simple coincidence detection system consists of a pair of radiation detectors with associated electronics and a coincidence circuit. Event will be recorded if annihilation occurs somewhere between two detectors and gamma quanta will interact with each of them.

Because all annihilation gamma quanta are emitted approximately 180° apart, a recorded coincidence indicates an annihilation occurred somewhere along the line connecting the two detectors. This line usually is referred to as a line of response or LOR.

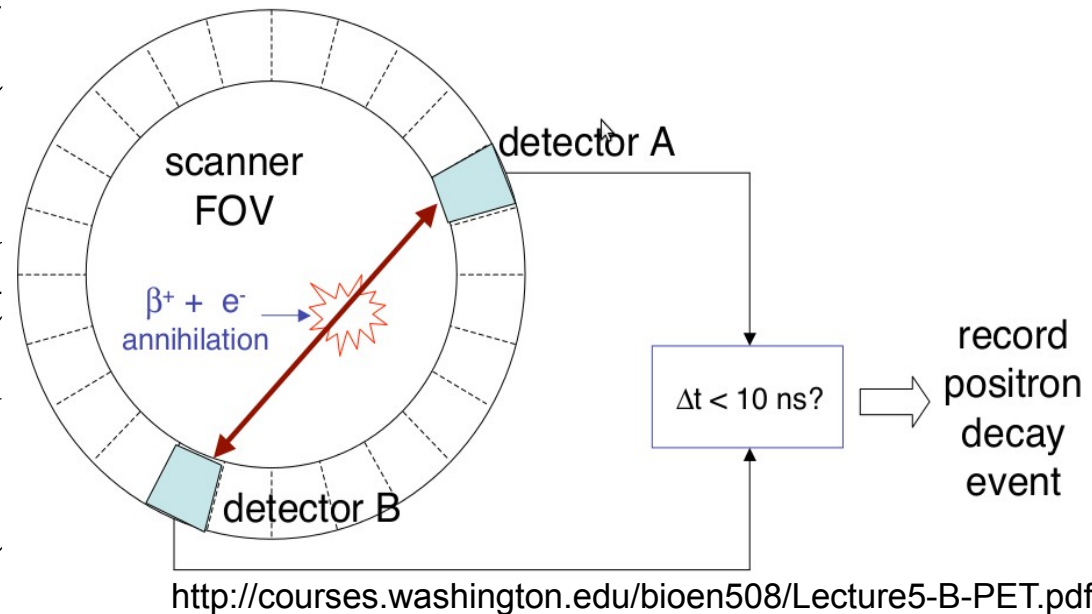

PET scanner – coincidence detection

- **Types of events:**
 - **true coincidence,**
 - **scattered coincidence,**
 - **random coincidence,**
 - **multiple coincidence.**

PET scanner – coincidence detection

- **Types of events:**
 - **true coincidence** - would be recorded only events where the two detected annihilation gamma quanta originate from the same radioactive decay and have not changed direction or lost any energy before being detected,
 - scattered coincidence,
 - random coincidence,
 - multiple coincidence.

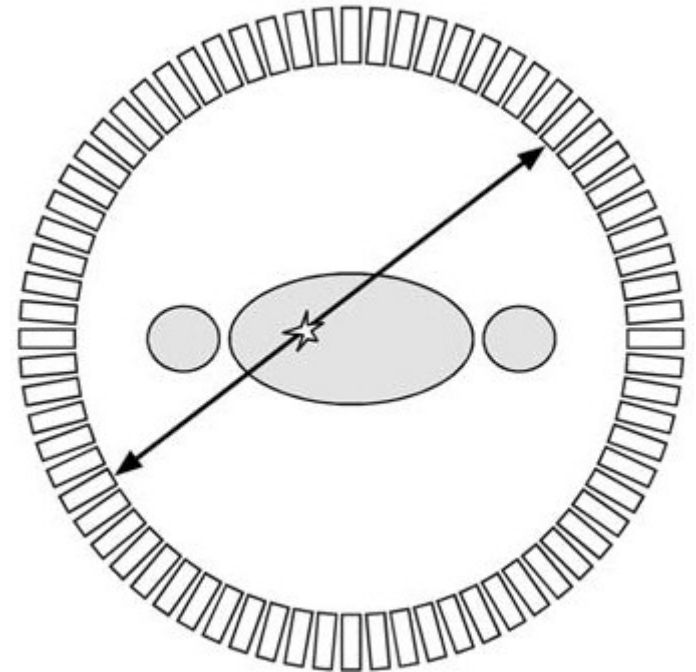

PET scanner – coincidence detection

- **Types of events:**
 - true coincidence,
 - **scattered coincidence** – one or both gamma quanta coming from annihilation interacts inside patient body what changes its direction and results in mispositioning the event,
 - random coincidence,
 - multiple coincidence.

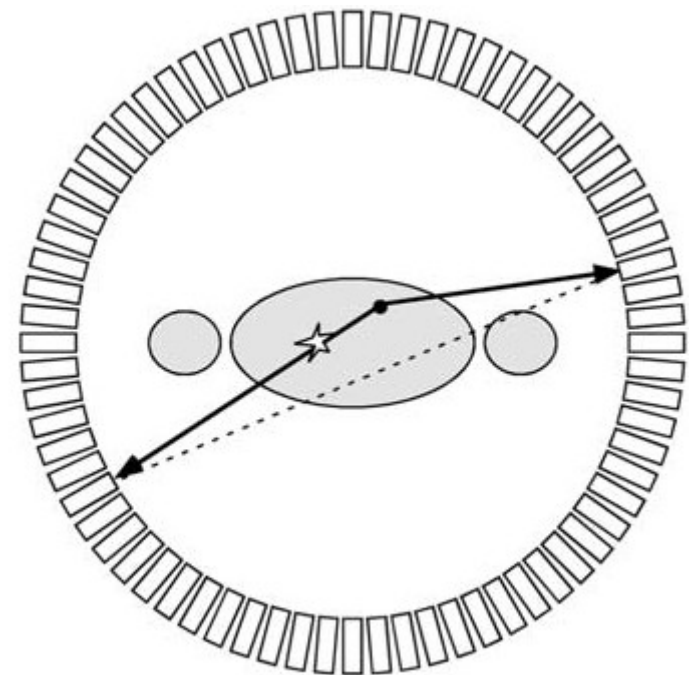

PET scanner – coincidence detection

- **Types of events:**
 - true coincidence,
 - scattered coincidence,
 - **random coincidence** - a coincidence is generated by two gamma quanta originating from two separate annihilations,
 - multiple coincidence.

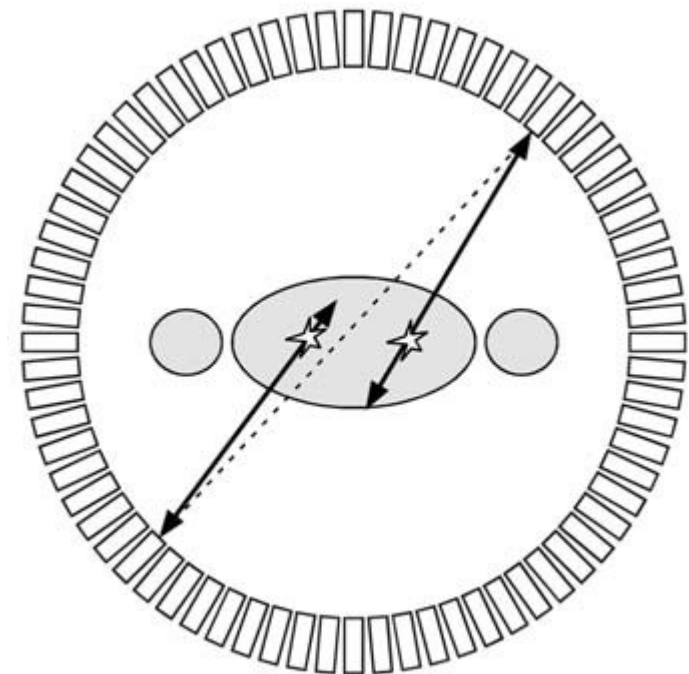

PET scanner – coincidence detection

- **Types of events:**
 - true coincidence,
 - scattered coincidence,
 - random coincidence,
 - **multiple coincidence** - three or more gamma quanta are detected exactly in the same time what results in the ambiguity of where to position the events.

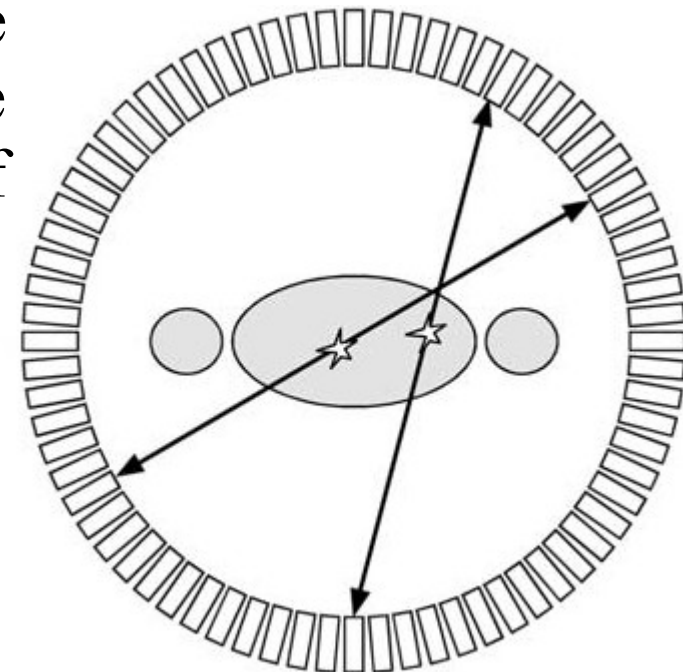

PET TOF

One can find **point of annihilation** lying on **Line Of Response (LOR)** which **connects two opposite block detectors**. To find **actual position** of radioactive atoms one could use **time difference between arrival time** of the **two gamma quanta** at the detectors. For annihilation closer to first detector arrival time will be smaller than for second detector. For annihilation exactly in the middle of LOR time difference will be equal to zero.

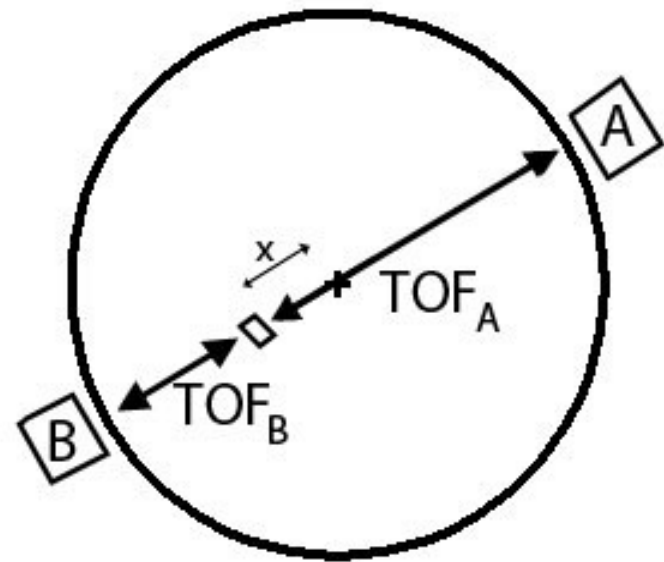

PET TOF

The relationship between the difference in arrival time of the two annihilation gamma quanta is given by:

$$TOF_A = \frac{x}{c} + \frac{L/2}{c},$$

$$TOF_B = \frac{L/2}{c} - \frac{x}{c},$$

L – distance between two opposite detectors, c – speed of light, x – distance between point of annihilation and the middle of LOR.

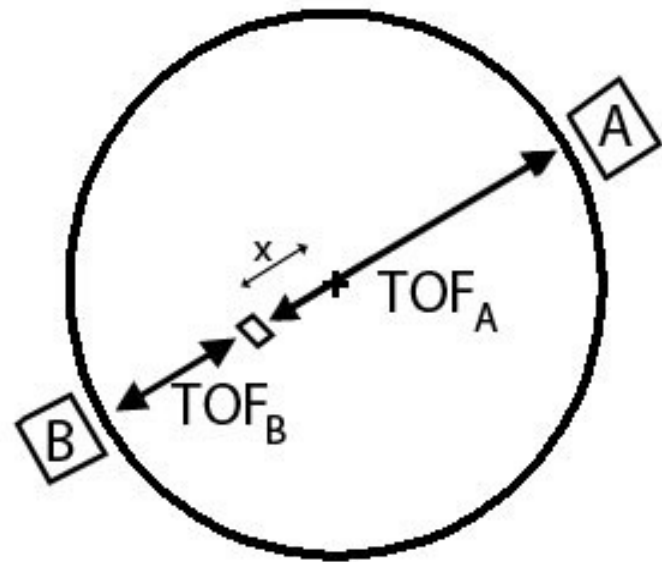

PET TOF

$$TOF_A - TOF_B = \frac{2x}{c}$$

So **localization uncertainty** is equal to:

$$\Delta x = \frac{c\Delta t}{2}$$

where Δx is localisation error, and Δt denotes time resolution of measuring the time difference between detectors A and B.

For **timing resolution** equal to **100ps**, a **position resolution** is equal to **about 1.5cm**.

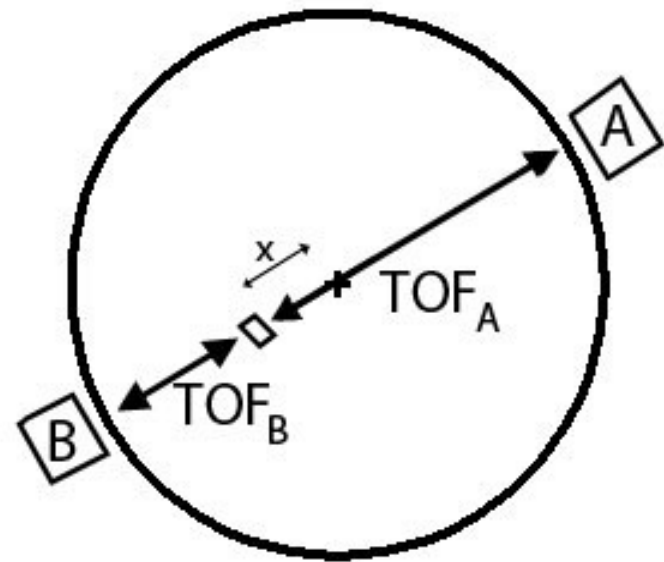

PET - clinical utility

- various applications,
- most common:
 - cardiology - myocardial viability and coronary heart disease,
 - oncology - cancers, lymphoma, melanoma, strokes, and tumors,
 - neurology - is used to distinguish recurrent brain tumors from radiation fibrosis or necrosis, one of the methods in localizing areas of the brain affected by epileptic seizures.

PET - clinical utility

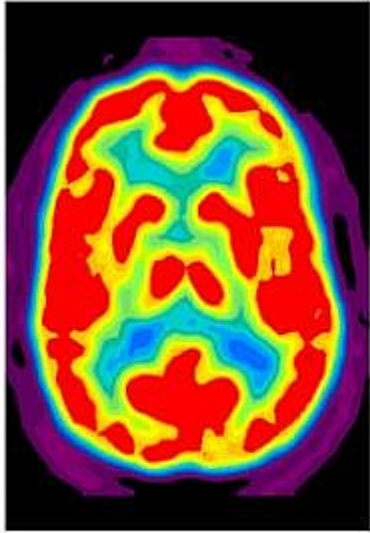

Normal

Consistent metabolic activity throughout the cerebral cortex

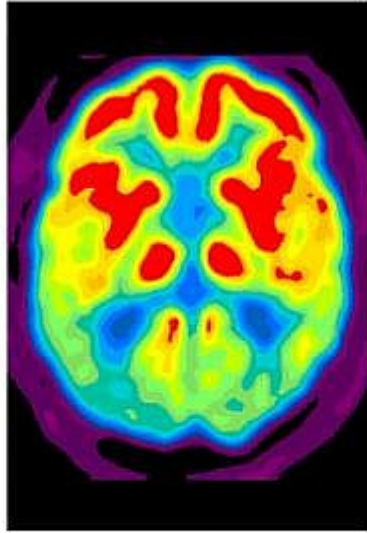

Alzheimer's Dementia

Reduced metabolic activity in the temporal and parietal lobes

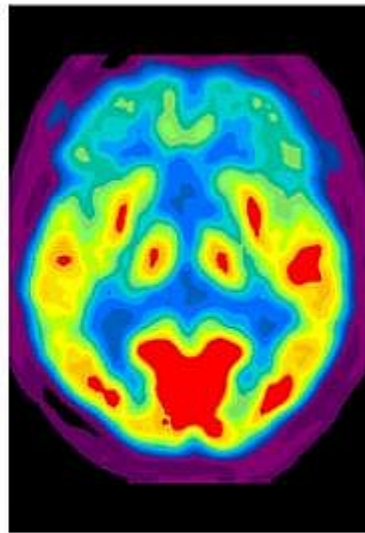

Frontal Lobe Dementia (Pick's Disease)

Reduced metabolic activity in the frontal lobe

<http://www.ncpic.org/OurServices/PET-CT/UsedForNeurology/>

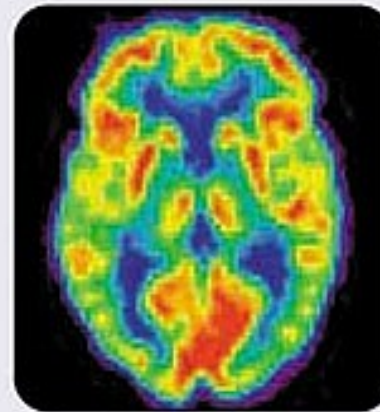

PET Scan of 20-year-old Brain

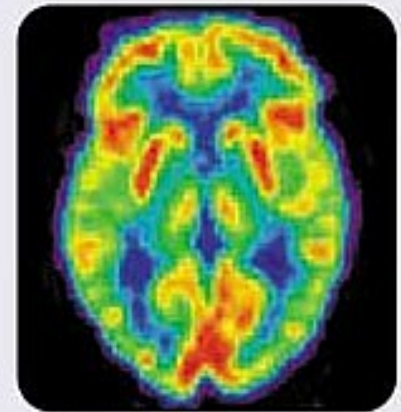

PET Scan of 80-year-old Brain

<http://www.web-books.com/eLibrary/Medicine/Appendix/PETscan.htm>

PET - clinical utility

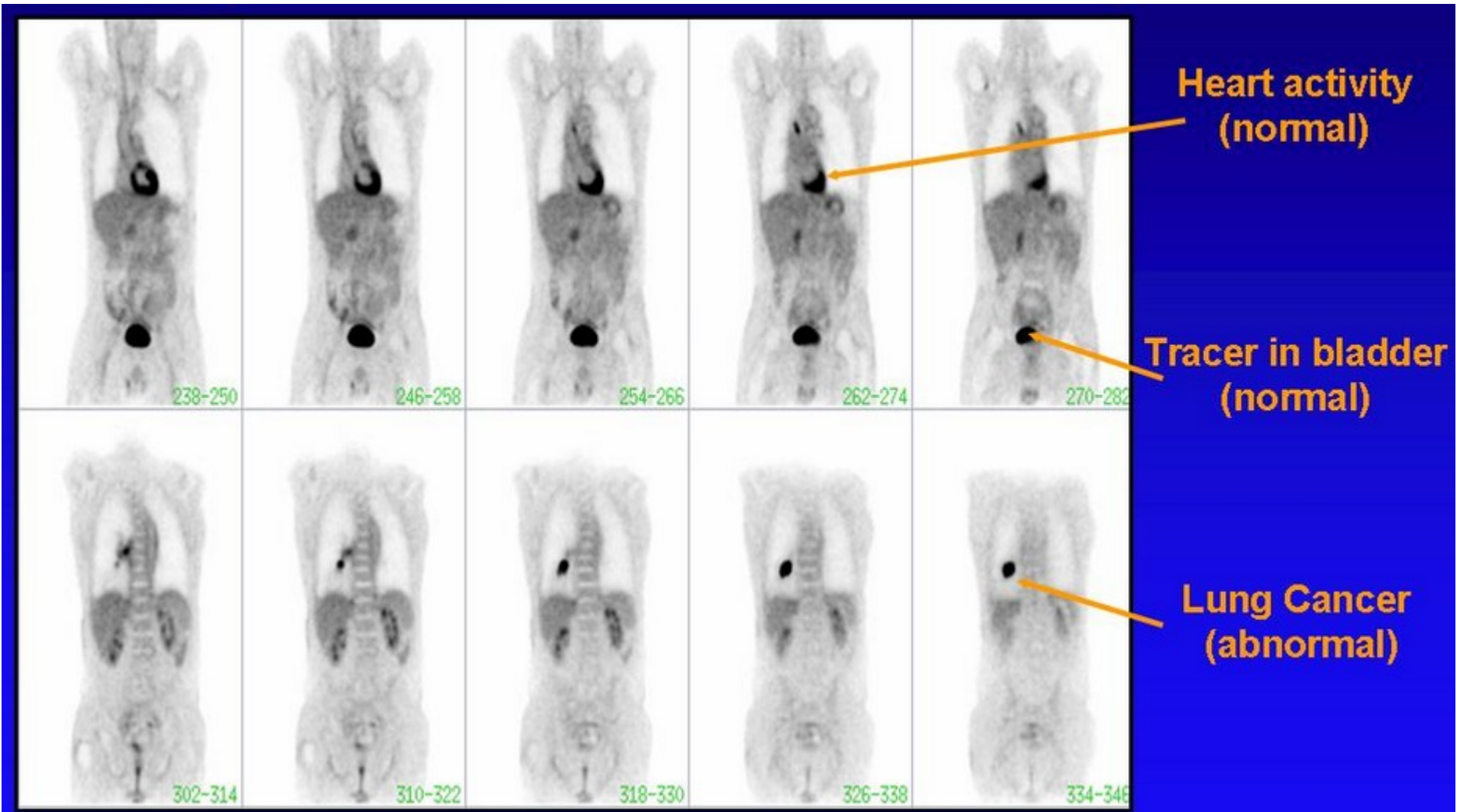

J-PET

- polymer scintillators arranged in a cylinder,
- light signals from each strip are converted to electrical signals by a system of two photomultiplier tubes located on opposite edges of the scintillator strip,
- point of interaction determined as time difference between signals on both ends of scintillator,
- time difference is determined as the arithmetic average of the measured times for both ends of the scintillator.

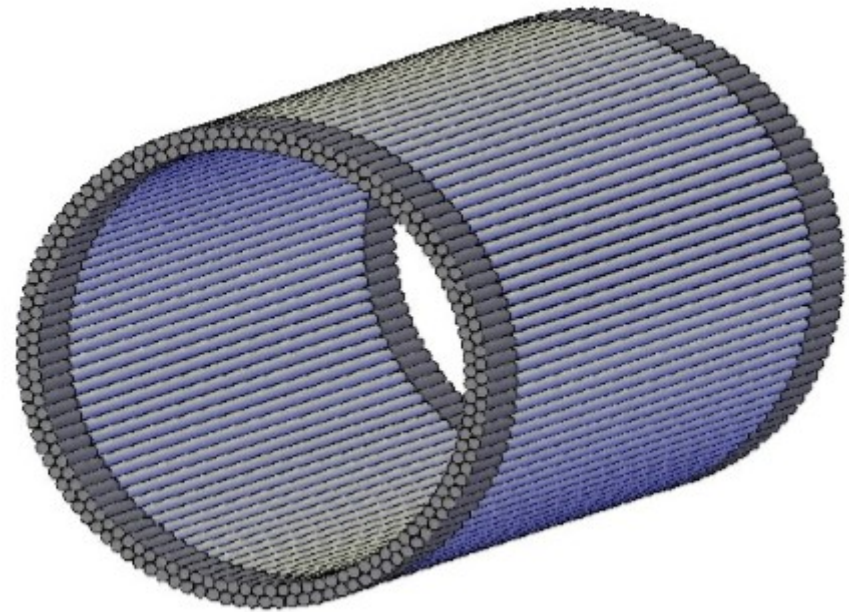
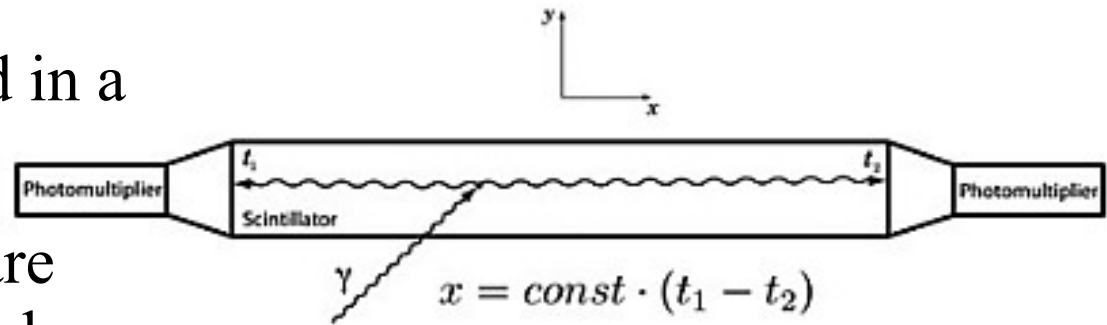

J-PET

$$\Delta l = \frac{(t_2 - t_1) \cdot v}{2} \cong \frac{(t_2 - t_1) \cdot c}{4}$$

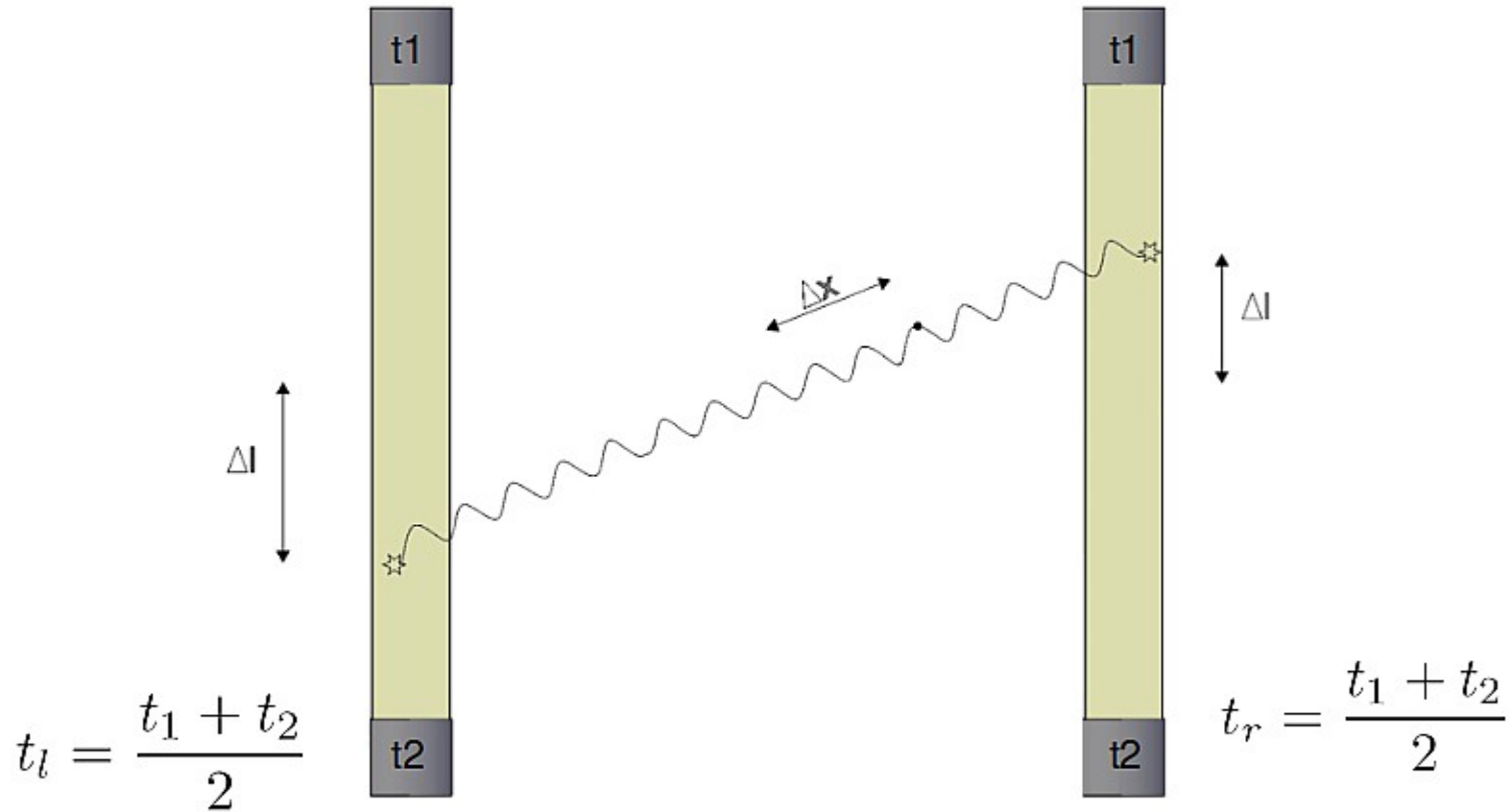

$$\Delta x = \frac{(t_l - t_r) \cdot c}{2} \implies \Delta x = \frac{\Delta t}{2} \cdot c$$

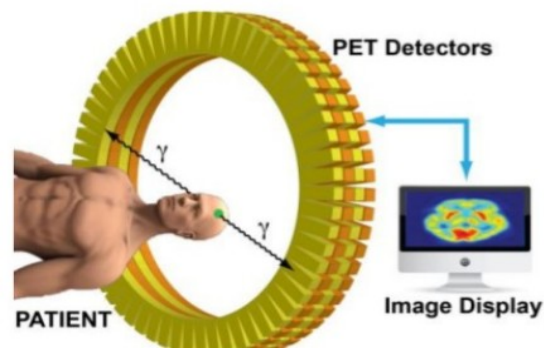

PET vs. J-PET

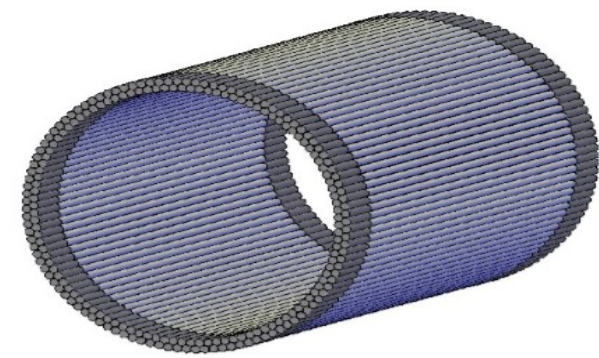

- crystal scintillators
- photoelectric effect
- based on energy measurement
- low acceptance
- analog electronics
- triggering
- body scan part by part
- expensive technique

- plastic scintillators
- compton effect
- based on time measurement
- high acceptance
- digital electronics
- triggerless
- simultaneous scan of a whole body
- cheaper technique

Master thesis

- **Title:** *The study of changes of the shape of the light pulses in a strip polymer scintillators,*
- **Aim:** to learn how basic parameters of signals change depend on scintillator shape,
- **Methodology:** investigation of the amount of light reaching the photomultiplier tube, its dependence on the scintillator shape and on the point of the interaction of gamma quanta with the scintillator material, impact of the wrapping on light transport inside scintillator.

Setup

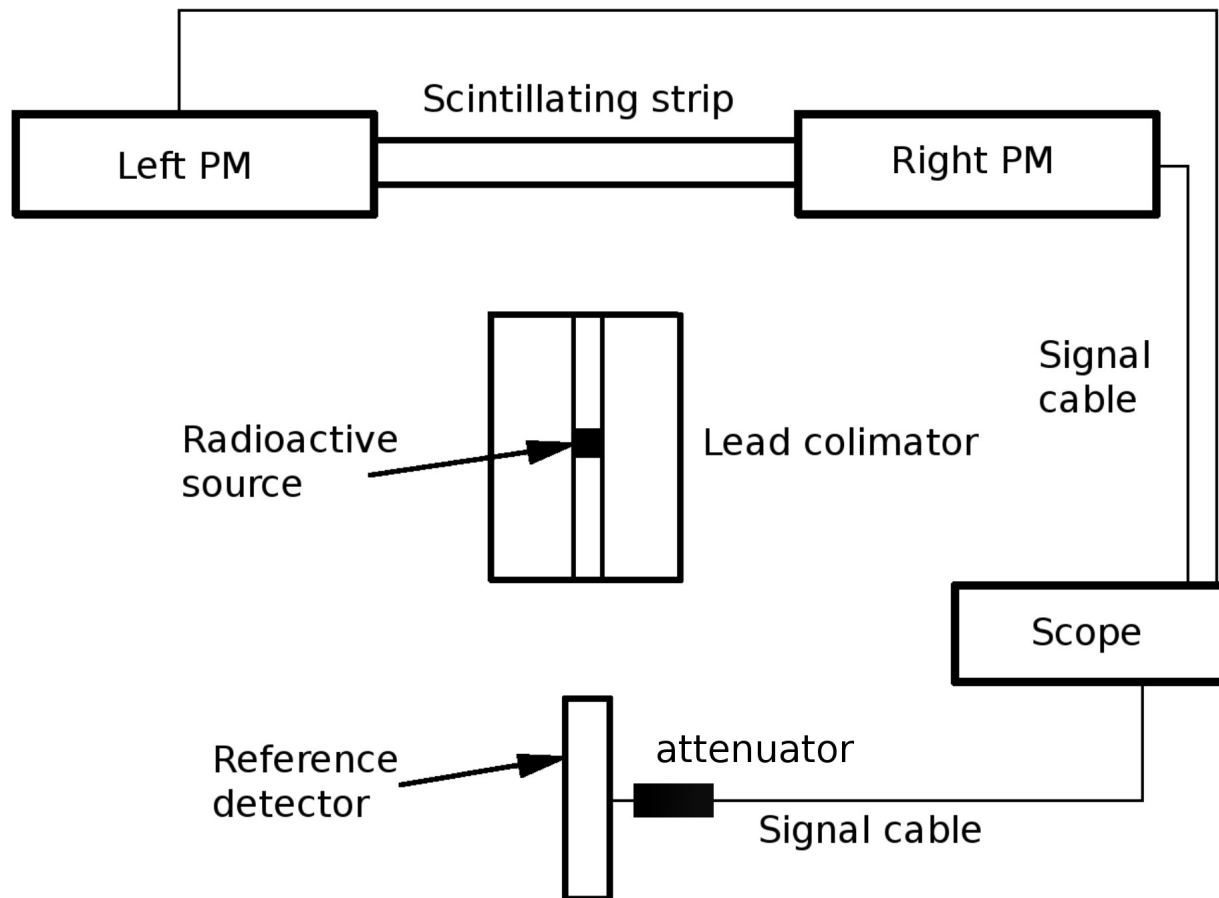

Setup

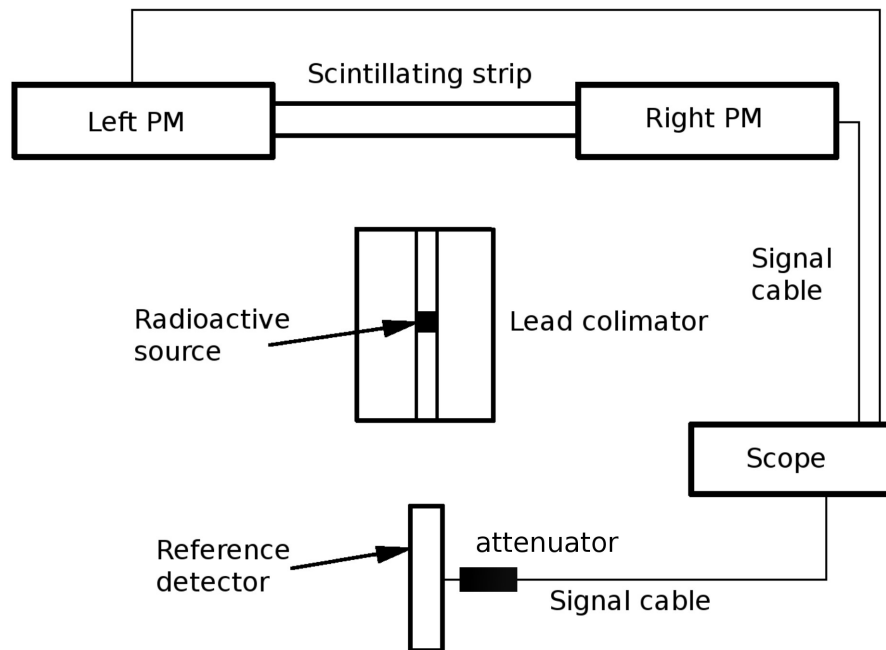

- photomultipliers produced by Hammmatsu, model R5320, bialkali photocathode, effective area 20mm dia., quartz window, linear-focused structure of dynodes,
- scintillator – EJ-230, different shapes, 50 cm long,
- reference detector connected to scope by 10dB attenuator,
- Germanium 68 source,
- tested scintillator wrapping – aluminum, tyvek and mylar foil.

Wrapping tests

- dependence of area spectra on wrapping (measurements done for 30cm long EJ-230 - dimensions of scintillator is: 0.5cm x 2cm x 30 cm)
- wrapping tests (right PM) at three different distances from one of the photomultiplier.

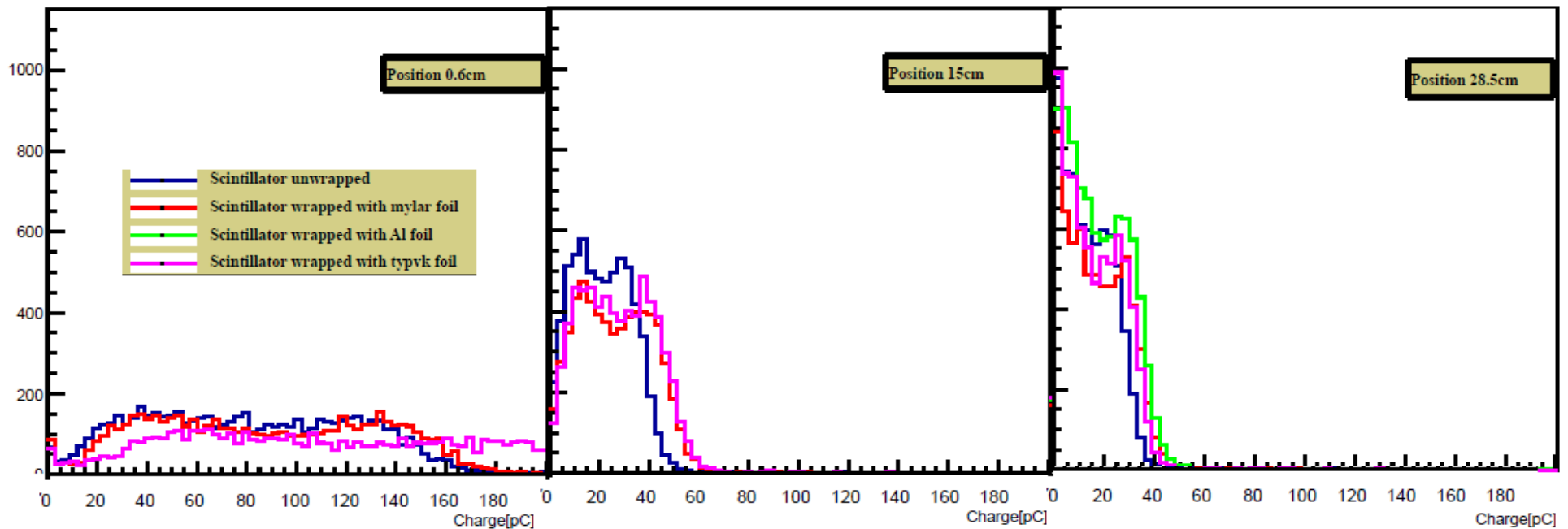

Wrapping tests

- dependence of area spectra on wrapping (measurements done for 30cm long EJ-230 - dimensions of scintillator is: 0.5cm x 2cm x 30 cm)
- wrapping tests (left PM) at three different distances from one of the photomultiplier.

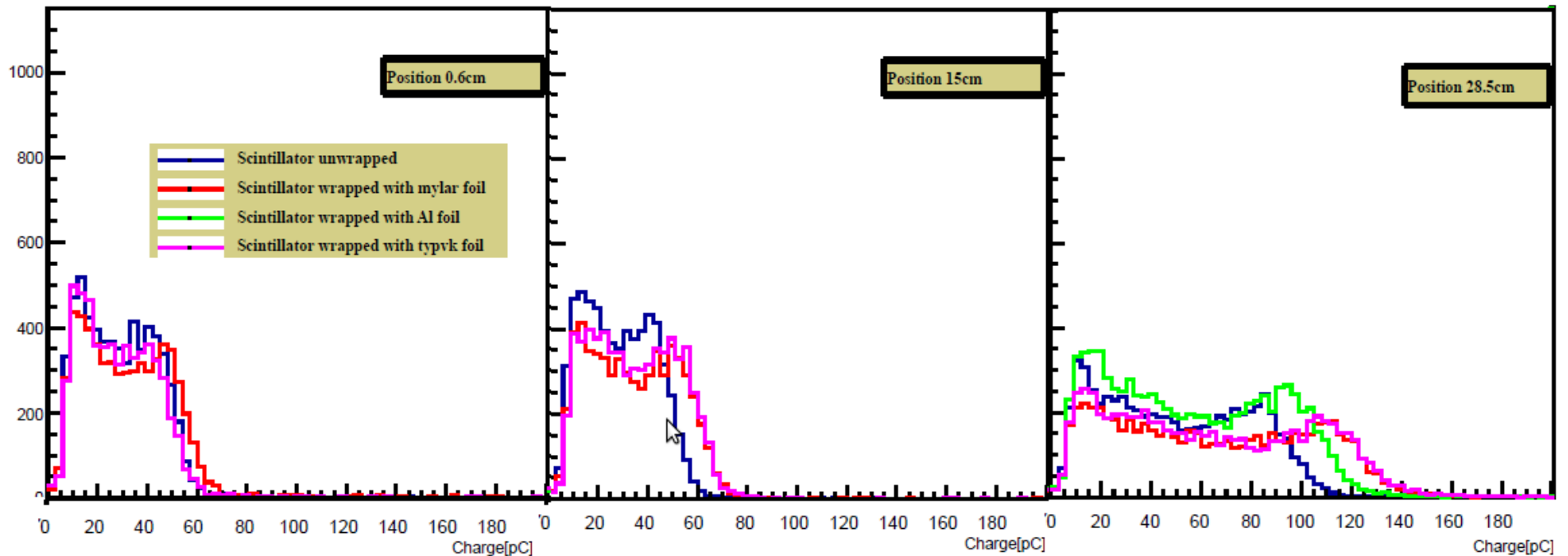

Wrapping tests

- dependence of area spectra on wrapping (measurements done for 30cm long EJ-230 - dimensions of scintillator is: 0.5cm x 2cm x 30 cm)
- distribution of square root of product of charges of photomultiplier signals $\sqrt{(Q_{Left} * Q_{Right})}$

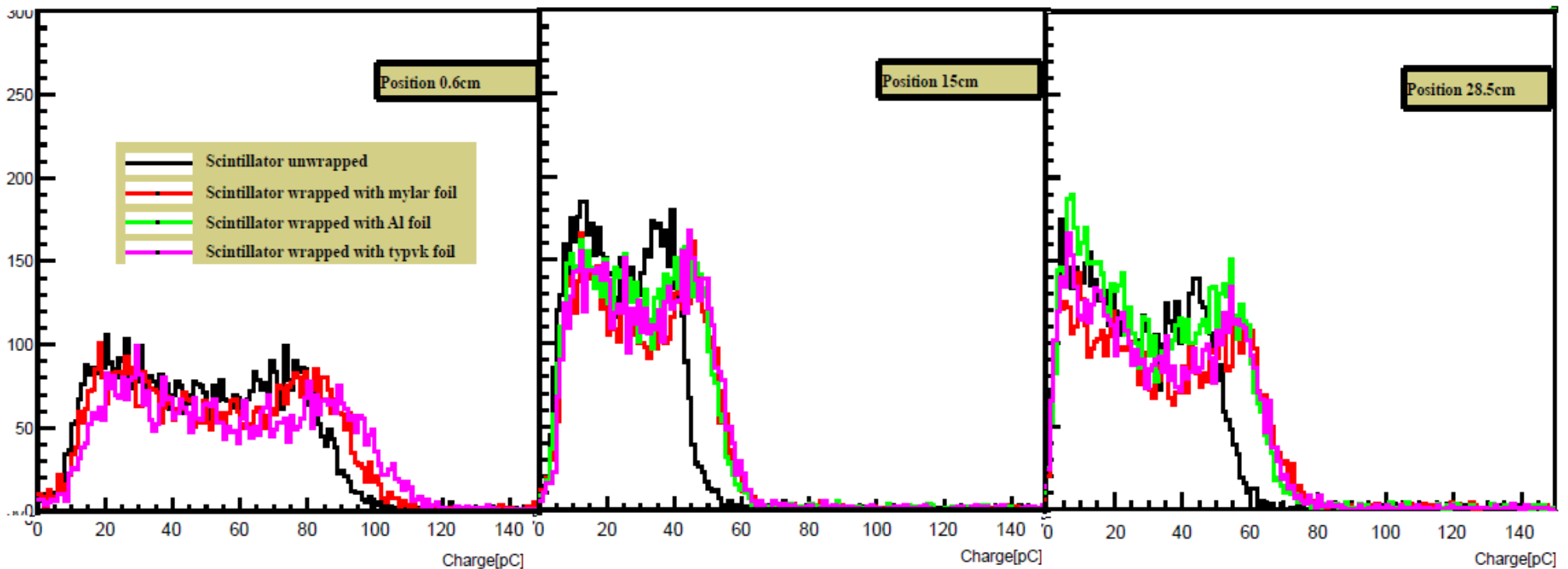

Wrapping tests

- dependence of area spectra on wrapping (measurements done for 30cm long EJ-230 - dimensions of scintillator is: 0.5cm x 2cm x 30 cm)
- Conclusion: we can use tyvek foil or mylar since both are producing the biggest area under signals, but tyvek foil is easier to use.

Speed of light

- results of speed of light for different shapes of scintillators, the best shape is small rod.

Shape	Speed \pm stat. \pm sys. [cm/ns]	Dimension [cm]
Small rod	$12.21 \pm 0.06 \pm 0.27$	1 dia. x 50
Big rod	$12.42 \pm 0.06 \pm 0.23$	1.6 dia. x 50
Rectangular	$12.61 \pm 0.05 \pm 0.21$	0.5 x 1.9 x 50
Square	$13.24 \pm 0.08 \pm 0.24$	1.4 x 50
Triangle	$13.34 \pm 0.08 \pm 0.13$	1.7 side x 50
Hexagonal	$13.43 \pm 0.09 \pm 0.05$	0.9 side x 50

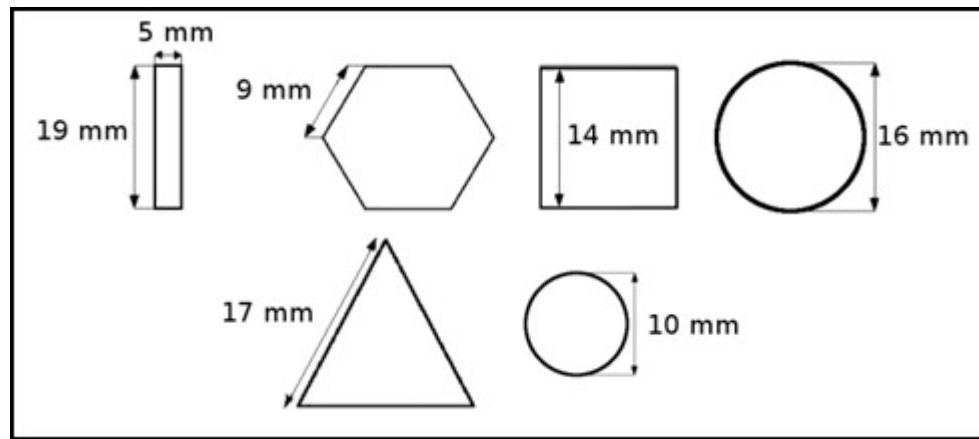

Area under signals for different shapes of scintillators

- preliminary results

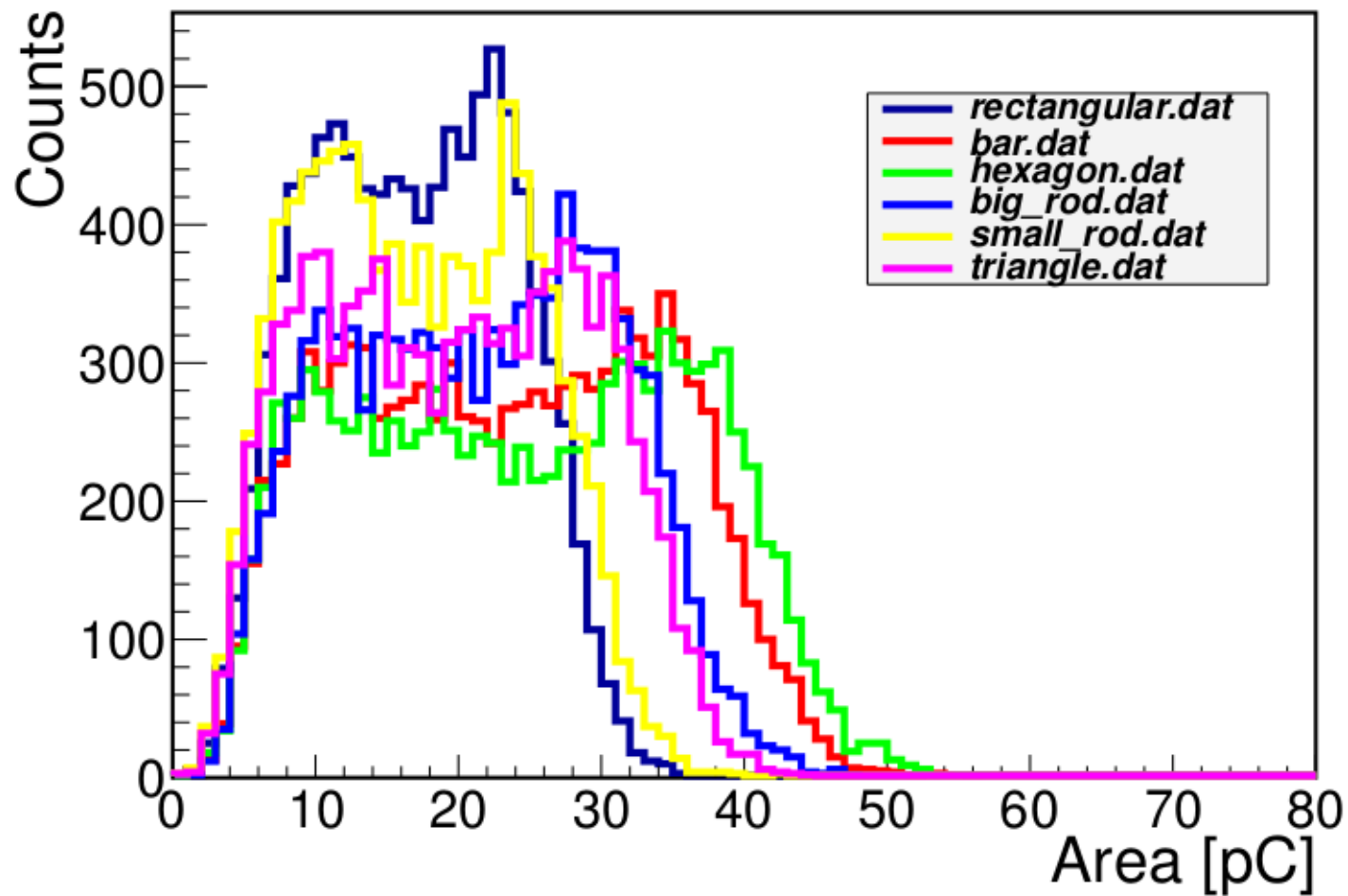

Area under signals for different shapes of scintillators

- best shape: hexagon, but bar shape is not much worse,
- worst shape: rectangular, but this scintillator was found to be damaged by the frequent usage.

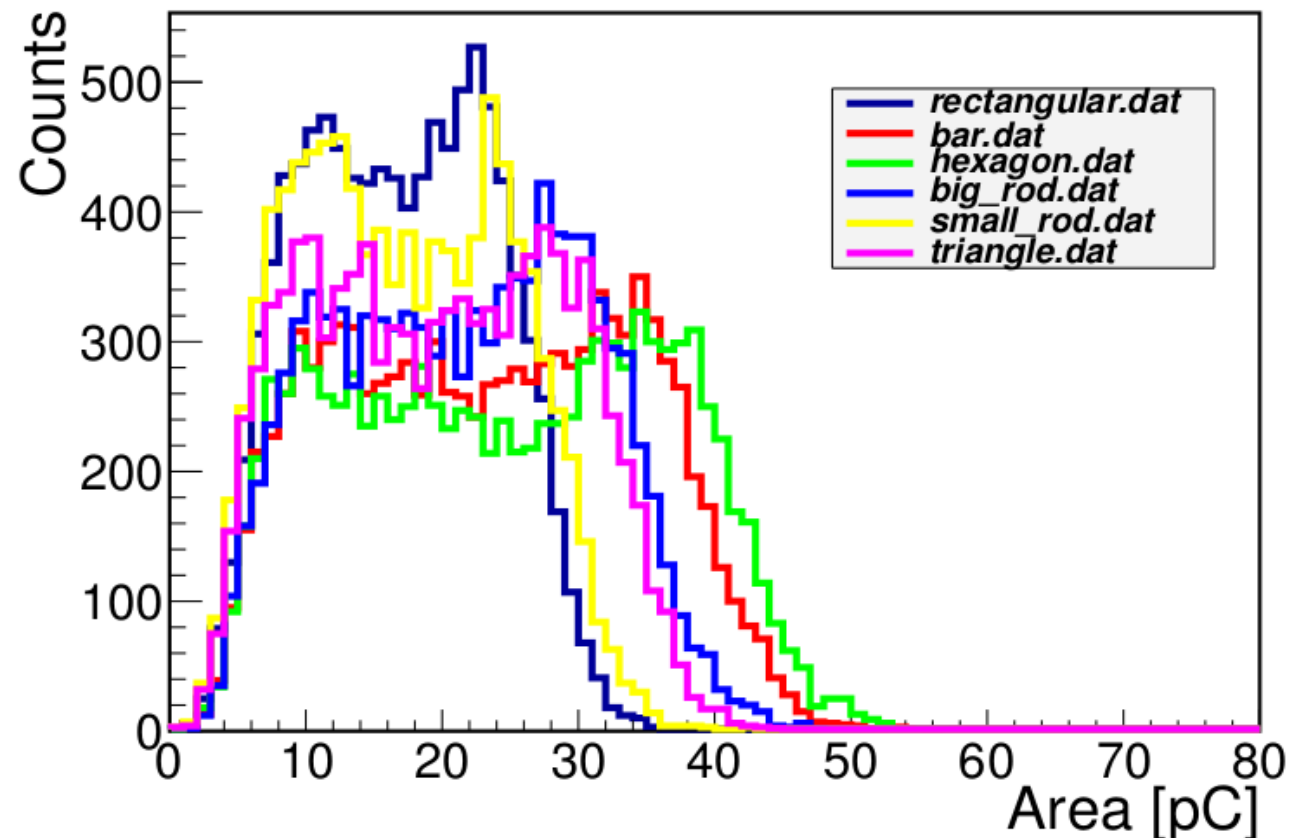

References

- History of PET: <http://advancedbiomarker.com/pdfs/HistoryOfPet.pdf>
- Case Study: Positron Emission Tomography
http://chemwiki.ucdavis.edu/Physical_Chemistry/Nuclear_Chemistry/Case_Studies/Radiation_in_Biology_and_Medicine/Case_Study%3A_Positron_Emission_Tomography
- Radiopharmaceuticals:
<http://www.euromedic.pl/pet-ct/dla-pacjent%C3%B3w/informacje-dla-pacjent%C3%B3w.aspx>
<http://www.rsc.org/learn-chemistry/resource/rws00396785/fludeoxyglucose-18f>
- Michael E. Phelps, *PET - Physics, Instrumentation, and Scanners*, Springer, 2006
- M. Wernick, *Emission Tomography The Fundamentals of PET and SPECT*, Elsevier Inc., 2004

References

- S. N. Ahmed, *Physics and engineering of radiation detection*, Elsevier Inc., 2007
- P. Moskal, *A novel TOF-PET detector based on organic scintillators*, International Conference on Translational Research in Radiation Oncology, Geneva, 10-14 February 2014
- Sz. Niedźwiecki, *Studies of detection of γ radiation with use of organic scintillator detectors in view of positron emission tomography*, master thesis
- T. Bednarski, *StripPET: Concept of TOF-PET scanner based on polymer scintillator strips*, PETRAD, Conference on Positron Emission Tomography in Research and Diagnostics 2012