

Nuclear physics in medicine, minefield and kitchen

Paweł Moskal*

Institute of Physics, Jagiellonian University, 30-059 Cracow, Poland

ABSTRACT

A plethora of phenomena discovered and investigated in the Maria Curie laboratories nowadays constitute basis of functioning of various advanced devices used in modern science, industry and medicine. In this article we briefly describe a few examples of nuclear physics applications such as: non-invasive imaging of living organisms by means of Positron Emission Tomography, remote identification of explosives and other dangerous substances using the technique of atometry, and preservation of food by its exposure to nuclear radiation.

1. INTRODUCTION

The basic research, driven by a pure curiosity about functioning and properties of matter and by the hope of discovering unknown phenomena, pushes the frontiers of technologies and constitutes the base for the development of civilized societies. Maria and Pierre Curie are excellent examples of esteemed scientists whose discoveries resulted in better understanding of nature, in the development of new fields of research such as nuclear physics and nuclear chemistry and who, as consequence of their research, led to the development of techniques which are widely used in modern industry and medicine.

Soon after the discovery of polonium and radium by Maria and Pierre Curie both new elements were used for cancer treatment. Jan Danysz together with Pierre and Maria Curie were one of the first who investigated

* E-mail address: p.moskal@uj.edu.pl

the response of cancer to irradiation with radium [1]. Pierre Curie even studied the action of radium on his own arm [2]. Pioneering studies by Jan Danysz and Pierre Curie of the influence of irradiation on living organisms led to modern conscious usage of nuclear radiation not only in cancer therapy but also in a broad range of applications requiring reduction of microbes and pathogens as e.g. in food industry, decontamination of water, disinfection of medical devices and in transplantation.

In this article we briefly present few examples of applications of nuclear physics techniques: (i) in non-invasive imaging of physiological processes of living organisms, (ii) in remote detection and identification of explosives, and (iii) in food preservation.

At first we describe Positron Emission Tomography (PET) which is at present one of the most technologically advanced diagnostic methods that allows for non-invasive imaging of physiological processes occurring in the bodies of animals and human beings. The method combines achievements in the field of medicine, physics, chemistry, electronics and computer science. However, its very principle embodies phenomena known from nuclear physics. The method requires an application of a short lived radioactive isotope constituting part of a radio-pharmaceutical administered to the patient. Thus, it is based on the phenomenon of artificial radioactivity discovered in the Radium Institute in 1934 by Irène and Frédéric Joliot-Curie, just before the death of Maria Curie who could still experience the next significant discovery in her Laboratory. Yet she could not enjoy the fact that for this achievement her daughter received one year later the Nobel Prize in chemistry. The married couple Joliot-Curie were also two of the first persons in the world who saw in their experiments positrons discovered in 1932 by Anderson (Nobel Prize in physics in 1936) which nowadays permit tomographic imaging of processes taking place in the living organisms. The most commonly used isotope in the Positron Emission Tomography is fluorine ^{18}F . It is worth mentioning that the first radioactive isotope of fluorine (^{17}F) was discovered in 1934 by Marian Danysz (co-discoverer of the hyper-nucleus in 1952) and M. Żyła when they were working in the Warsaw Radiological Laboratory as students of Ludwik Wertenstein [3]. This Laboratory was founded and formally directed by Maria Curie. The fluorine (^{17}F) was produced in the reaction $^4\text{He} + ^{14}\text{N} \rightarrow ^{17}\text{F} + \text{n}$, thus using the method of Irène and Frédéric Joliot-Curie. It is also worth mentioning that nuclear imaging was one of the subjects of studies of Maria Curie who, by analogy to X-ray radiography, was

trying to develop imaging by means of radium [2]. Figure 1 presents one of radiumgraphs taken by Maria Curie.

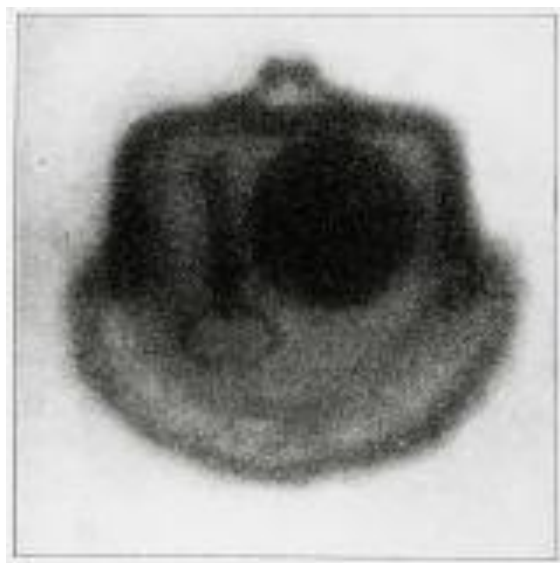

Fig. 1 Radiumgraph taken by Maria Curie by exposing a purse to radium. A key is visible on the left side of the purse. Photo was taken from <http://www.galloimages.co.za/>.

Atometry is the second application of basic nuclear physics which will be described in this article. This technique allows for the identification of atomic composition of substances by irradiating them with neutrons, thus exciting the nuclei to the higher energetic states which subsequently de-excite by the emission of gamma quanta with element-characteristic energy. The emitted gamma quanta carry to the detectors information about the stoichiometry of the investigated objects [4,5]. Here it is worth mentioning that neutrons (crucial for this technique) were first detected in the Radium Institute by Irène and Frédéric Joliot-Curie in the ${}^4\text{He} + {}^{27}\text{Al} \rightarrow {}^{30}\text{P} + \text{n}$ reactions and were then called neutral rays. However, only James Chadwick in 1932 interpreted the neutral rays properly as neutrons for which he received the Nobel Prize in physics in 1935. Two other basic phenomena underlying the method of atometry are the inelastic scattering of neutrons and the excitation of the nucleus. Excited states of the nucleus were discovered in 1921 by Samuel Rosenblum, and in 1934 Józef Rotblat (Nobel Peace Prize 1995) discovered in the Warsaw Radiological Laboratory that neutrons may undergo the non-elastic interactions initiating the

nuclear reactions. Atometry may be applied for detection of landmines, car bombs, drugs and even for diagnosis of cancers.

Development of the aforementioned techniques is a continuation of Maria Curie's endeavor. Expressed in her words: *"It is easy to understand how important for me is the conviction that our discovery is a blessing for humanity not only by its scientific importance but also because it permits the reduction of human suffering and treatment of a terrible disease. This is indeed a great reward for the years of our enormous effort"* [2]. And she also appealed that *"Therapy should be permanently backed up by scientific research without which no progress is possible"* [2].

2. MEDICINE: POSITRON EMISSION TOMOGRAPHY

Many devices used in modern medical diagnostics and therapy are based on phenomena discovered by nuclear physicists at the turn of 19th and 20th century. Technologies transferred to medical applications from nuclear physics laboratories proved to be especially useful in noninvasive imaging of the interior of the human body. Here one can mention such techniques as Roentgen Tomography (commonly known as Computer Tomography), Nuclear Magnetic Resonance Tomography (commonly referred to as Magnetic Resonance Tomography), Single Photon Emission Computed Tomography, Positron Emission Tomography and plethora of other techniques. In the following we will concentrate on the Positron Emission Tomography which permits us to determine spatial and temporal distribution of concentrations of selected substances in the body. To this end, the patient is administered pharmaceuticals marked with radioactive isotope emitting positrons. Most commonly a FluoroDeoxyGlucose ($C_6H_{11}^{18}FO_5$) with fluorine-18 (^{18}F) isotope is used. This radioactive sugar (denoted as ^{18}F -FDG) undergoes a usual metabolism in the body and is absorbed in cells analogously to glucose, yet once absorbed it remains inside the cell. Consequently, the decay of fluorine-18 occurs mostly inside the cells in which the fluorodeoxyglucose was absorbed. Therefore, the density distribution of ^{18}F reflects the product of concentration with rate of metabolism of cells using ^{18}F -FDG. Since the rate of assimilation of marked pharmaceuticals depends on the type of the tissues, sections of the diseased cells can be identified with high accuracy, even if they are not yet detectable via morphological changes. PET is therefore extremely effective in locating and diagnosing cancer metastases.

Fluorine ^{18}F decays into oxygen ^{18}O , a positron and a neutrino. A patient's body is built out of electrons, protons and neutrons. The regions where ^{18}F decays in the body may be reconstructed due to the fact that the positron annihilates with electron and their mass is converted to energy in the form of gamma quanta. Most frequently, in 99.7% of cases, these are two gamma quanta which due to momentum and energy conservation and the fact that annihilation of positron with electron occurs almost at rest, are flying nearly in opposite directions with energy close to the mass of the electron. PET locates the radioactive marker with the use of radiation detectors, allowing reconstruction of the direction of flight of annihilation quanta. Radiation detectors are usually arranged in layers forming a ring around the diagnosed patient (see left panel of Fig. 2).

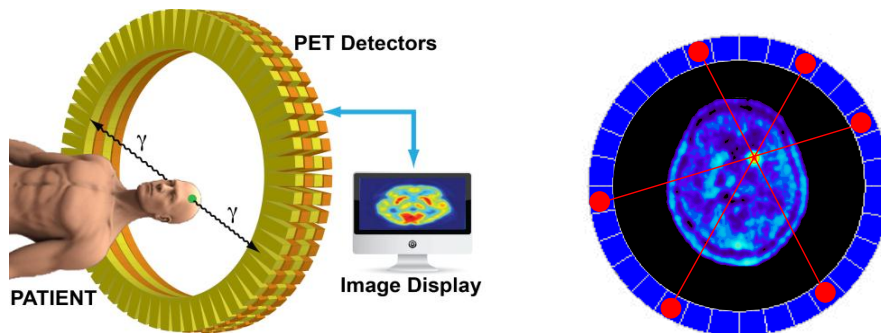

Fig. 2 (Left) Schematic view of the PET diagnostic system. (Right) Illustration of the idea of the image reconstruction. Three lines of response are indicated in red.

The set of reconstructed lines (referred to as Line of Response: LOR) constitutes the basis for the reconstruction of the tomographic image which reflects the distribution of the density of the radio-pharmaceuticals in the body of the patient. This technique allows investigations of the dynamics of physiological processes involving the radio-pharmaceuticals since PET can obtain a few tens of images within a minute.

In the right panel of Fig. 2 we present, in great simplification, the idea of the image reconstruction. The figure shows three lines of response which originate from three annihilations which occurred in the same place. Red points indicate the centers of the detectors in which the gamma quanta were registered. The crossing point of lines of response indicates the place where

the annihilations took place. In reality, annihilations are spread over the whole body and in order to extract the density distribution of decay points of the fluorine-18, application of image reconstruction techniques is mandatory.

There are not so many isotopes undergoing the beta plus decay with half-life suitable for PET diagnostics. Some of them are listed in Tab. 1.

Table 1. Radioactive isotopes used frequently in the PET diagnostics [6]. Indicated isotopes are components of molecules playing important roles in the metabolism of living organisms and are therefore crucial for Positron Emission Tomography.

Isotope	Average range of positrons in water [mm]	Maximum energy of positrons [MeV]	Half-life [minutes]
^{11}C	1.7	0.960	20.4
^{13}N	2.0	1.198	10.0
^{15}O	2.7	1.732	2.0
^{18}F	1.4	0.633	109.8

Fluorine ^{18}F is one of the most suitable isotopes for PET imaging due to its relatively long half-life equal to about 110 minutes and the relatively small energy of emitted positrons which is maximally equal to about 0.64 MeV. The mean lifetime of ^{18}F is long enough to produce the isotope, synthesize the pharmaceuticals, deliver it to the hospital and finally to carry out a diagnosis. Fluorine ^{18}F may be produced e.g. in the reaction of protons with ^{18}O nucleus via the $^{18}\text{O}(p,n)^{18}\text{F}$ reaction. The reaction is usually realized by impinging a beam of protons, accelerated by means of a cyclotron, onto a target of water enriched in H_2^{18}O molecules.

A natural limitation of the sharpness of a PET image is given by the fact that positrons annihilate predominantly when their kinetic energies are decreased to the values close to zero (below keV) [7], which is typically a few millimeters away from the nucleus from which they were emitted. The distribution of energy of positrons emitted by ^{18}F , and a way they interact with electrons, results in an average distance (in water) between decay and annihilation point of about 1.4 mm. Thus, 1.4 mm is a natural limitation of the sharpness of PET image when using ^{18}F tracer. With regards to the detection technique, an unknown depth at which a gamma quantum reacts with a

detector (referred to as DOI - Depth Of Interaction) is one of the main factors limiting presently achievable accuracy. The LOR is reconstructed under assumption that the signals emerged in the middle of the detection modules, and hence the size of the single module limits the spatial resolution (sharpness) of the image.

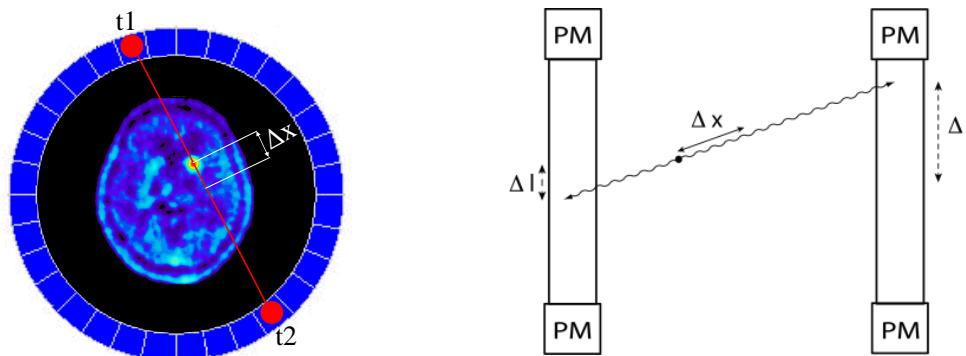

Figure 3. (Left) Illustration of the idea of PET-TOF; $\Delta x = (t_2 - t_1) c/2$, (Right) Schematic few of the new PET concept referred to as strip-PET. The hit position versus the center of the scintillator (Δl) is determined based on time difference measured on both sides of the scintillator strip, and the position (Δx) along the LOR is determined from time difference measured between two modules. PM denotes the photomultipliers.

A way to improve the reconstruction of the tomographic image is the determination of the annihilation point along the line-of-response based on measurements of the time difference between the arrival of the gamma quanta to the detectors. This technique is known in nuclear physics as TOF (time of flight), and tomographs which use time measurements are termed TOF-PET [8]. In the idealized case, as it is shown in Fig. 3, measurement of the difference between arrival times of the quanta ($t_2 - t_1$) could allow reconstruction of the annihilation point relative to the center of the line-of-response denoted in the picture as Δx . In practice, due to the finite resolution of the time measurement, it is possible to determine only a range along LOR in which the annihilation occurred, which improves the reconstruction of PET images by reducing the noise to signal ratio. Currently all commercial PET devices use inorganic scintillator materials as radiation detectors. A first commercial TOF-PET constructed in 2006 by PHILIPS based on LYSO scintillator crystal achieved 650 ps (FWHM) for time-of-flight resolution. In 2008 a prototype made by SIEMENS achieved the time resolution of about 550 ps with a

scanner based on LSO crystals, which corresponds to a spatial resolution along the line-of-response of about 8 cm. The TOF reconstruction reduces the noise propagation along the LOR during the reconstruction. The improvement of the TOF resolution from the present 550 ps to 100 ps would improve the signal to noise ratio by as much as a factor of 6 [8]. In principle with a TOF resolution of 30 ps the density distribution of annihilation points could be obtained with a spatial resolution of 5 mm directly, without any sophisticated image reconstruction procedures. Such resolution is unrealistic with the presently available inorganic scintillators. However, 100 ps TOF resolution has for a long time been reachable for large scale detectors built out of plastic scintillators [9].

In the following we briefly described a solution for the PET detector based on the large size polymeric scintillators [10,11].

The idea of using strips of organic scintillators for PET, which can be easily produced in large sizes and various shapes, contrary to expensive inorganic crystals, is utterly new. The novelty of the concept lies in employing predominantly the timing of signals instead of their amplitudes. The solution proposed is based on the superior timing resolution available with organic scintillators which allows for the determination of position and time of the reaction of the gamma quanta based on the time measurement only. The idea of the functioning of such strip-PET detector is illustrated in the right panel of Fig. 3. Light signals from each strip are converted to electrical signals by two photomultipliers placed at opposite edges. To establish the impact position of the gamma quantum the time difference between signals from both ends of the strip is used and the time of the interaction of the gamma quantum in the strip is determined as an arithmetic mean of the times measured on both edges of the scintillator. One of the possible solutions for building the diagnostic chamber out of such strips is their arrangement in the form of a cylinder as it is shown in Fig. 4.

The point of impact of a gamma quantum in a plane perpendicular to the axis of the strips can be determined from the position of a module which registered the signal, while the position along the scintillation chamber is determined using the difference between times measured in the front and rear photomultipliers. Energy of the electron hit by gamma quantum is measured based on the amplitude of signals in the photomultipliers on both sides. Coincident registration of two gamma quanta allows determination of the line-of-response based on coordinates of reaction points reconstructed in both strips. The time of the reaction in each strip permits reconstruction of the annihila-

tion point along LOR based on the TOF method. The set of reconstructed LOR lines together with points of annihilation provides a base for reconstruction of a tomographic picture. At present the concept of a strip-PET detector is being investigated at the Jagiellonian University [10,11].

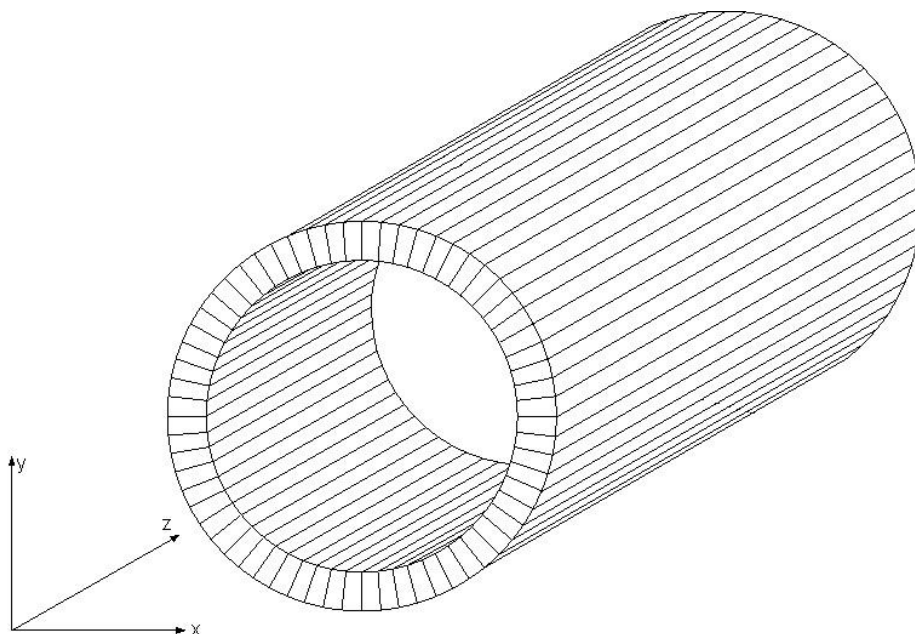

Fig. 4. Example of diagnostic chamber of the strip-PET. The chamber is formed from strips of organic scintillator.

3. MINEFIELD: ATOMETRY

Atometry permits, the remote and non-intrusive, identification of the chemical composition of unknown objects by means of nuclear radiation. The object could be, for example, an explosive material hidden in a car, a landmine in the ground, a section of cancer tissues in the body of a living organism, or cocaine in luggage.

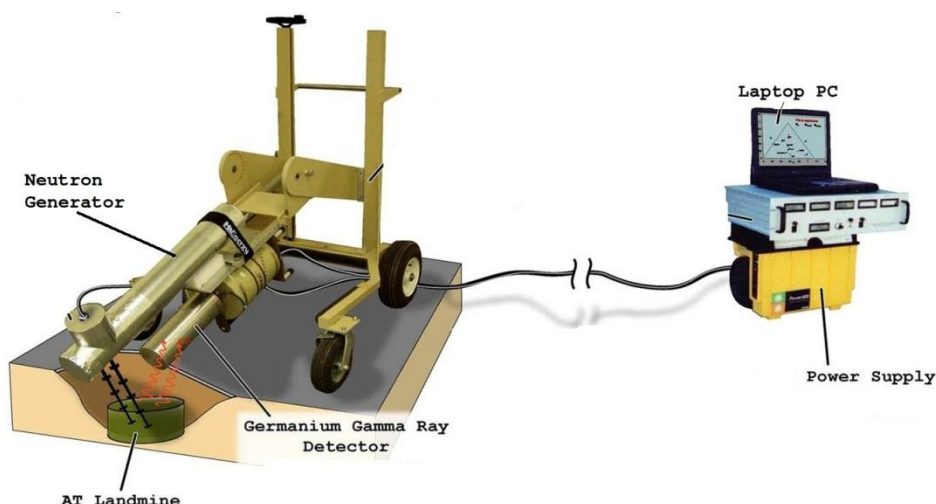

Fig. 5. Illustration of the system for explosive detection build out of a neutron generator and detector for gamma rays. In the figure only neutrons flying towards the landmine and gamma quanta towards detector are shown. In reality they are emitted isotropically in the full solid angle. The figure is adapted from [12].



The identification is based on the detection of the energy spectra of gamma quanta emitted by the atomic nuclei of the investigated object when irradiated by neutrons. Neutrons in an inelastic interaction may excite the nucleus to a higher energetic level which then de-excites via emission of the gamma quantum: $n + N \rightarrow N^* + n \rightarrow N + \gamma + n$. The energy spectrum of emitted gamma quanta is discrete and element specific. Therefore its observation allows for the univocal identification of irradiated atoms.

The method has been known for more than forty years. It is in principle simple and very attractive conceptually, but the first functioning device was produced only recently. The schematic illustration of an atometer device is shown in Fig. 5. It was developed by B. Maglich who aptly defined the technique as stoichiometry by means of elementary particles [4].

Neutrons and gamma quanta are neutral and may penetrate matter without loss of kinetic energy, and fraction of them can reach substances concealed even in pockets built out of steel, and then deliver information to the detectors about their molecular structure. Molecules of military explosives and drugs are built out of carbon, nitrogen, oxygen and hydrogen. A few examples are listed in Tab. 2. Independently of their complicated

structure these substances can be unambiguously identified by the determination of the ratio between number of C, N, O and H atoms. Neutrons may be produced using compact generators (see Fig. 5) based e.g. on deuterium-tritium fusion ($d + t \rightarrow \alpha + n$) where deuterons are accelerated to the energy of 0.1 MeV onto a solid target containing tritium. The kinetic energy of deuterons is very small in comparison to the excess energy available for the neutron and alpha particle (~ 17.8 MeV), therefore neutrons are emitted nearly isotropically with a well-defined energy equal to about 14.1 MeV. Such energy is sufficient to excite nuclei of carbon ^{12}C (4,43 MeV), oxygen ^{16}O (6,13 MeV) and nitrogen (2,31 MeV and 5,11 MeV), however it is much too small for the excitation of a proton (~ 300 MeV) and hence the amount of hydrogen cannot be examined using this method. Yet, explosives can be discriminated from non-explosives by the atomic ratio of carbon, oxygen and nitrogen only [4].

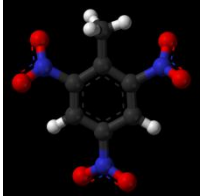
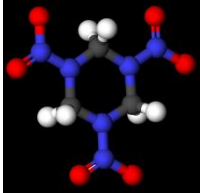
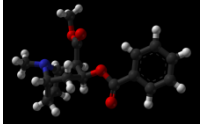
Table 2. Molecular formula of few chosen dangerous substances. The pictures are adapted from <http://en.wikipedia.org/>.

name	molecular formula	ratio C : N : O : H	molecular structure
trinitrotoluene (TNT)	$\text{C}_7\text{H}_5\text{N}_3\text{O}_6$	1.2 : 0.5 : 1 : 0.8	
hexogen Royal Demolition eXplosive (RDX)	$\text{C}_3\text{H}_6\text{N}_6\text{O}_8$	0.5 : 1.0 : 1.0 : 1.0	
cocaine	$\text{C}_{17}\text{H}_{21}\text{NO}_4$	4.25 : 0.25 : 1 : 5.25	
heroine	$\text{C}_{21}\text{H}_{23}\text{NO}_5$	4.2 : 0.2 : 1 : 4.6	

An isotropic generation of neutrons induces unfortunately a large background originating from irradiation of atoms from material surrounding the interrogated object. Even air (one cubic meter of air comprises about 1 kg of nitrogen) may obscure the energy spectra. This noise can be significantly reduced by the requirement of the coincident detection of the alpha particle. The two-body kinematics implies that in the reaction center-of-mass, the alpha particle is emitted at 180 degree with respect to the neutron. Due to the relatively small energy of deuterons, hence small velocity of the center-of-mass system, this angle remains nearly unaffected also in the laboratory. This allows for the tagging of the direction of neutrons by the registration of the direction of the alpha particle. The technique is known as Associated Particle Imaging (API), and in principle it should make it possible to obtain also tomographic 2D and 3D images of the investigated objects (Fig. 6).

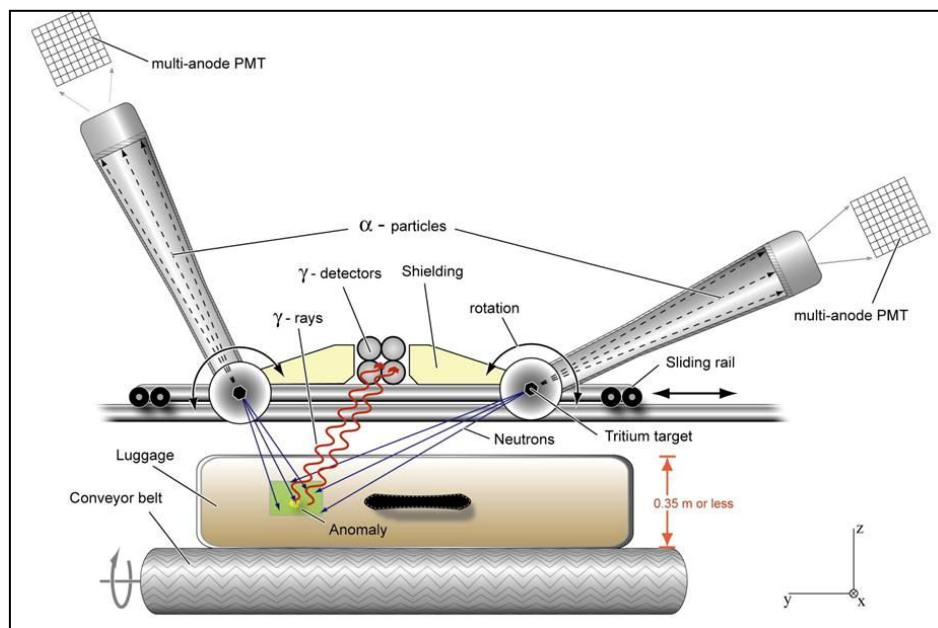

Fig. 6. Schematic view of the Associated Particle Imaging system. The picture is taken from [12].

Atometry is thus a very promising method which may find applications in remote and non-invasive detection and identification of explosives and drugs as well as in medical diagnostics where it can be used for the identification of cancer tissues. The latter may be achieved by identifying

the fraction of oxygen atoms which e.g. in “hypoxic” cancerous tumors is 50% to 90% less than in healthy tissue [13]. The method is presently being developed by the CALSEC scientists who aimed at painless cancer diagnosis from outside the body with power of recognizability the same as that of surgical biopsy [13].

The World Health Organization reports that cancer is a main cause of death worldwide. Landmines kill or maim on average one person every twenty minutes [4]. It is thus undeniable that the development of atometry can save a tremendous amount of suffering. Hence, it is beneficial to combine basic and applied research in the field of modern nuclear physics and to follow the example of Maria Curie who was producing polonium and radium for radiotherapy, who during the First World War organized eighteen mobile (radiological ambulances) and two hundred permanent X-ray units in order to improve surgical treatment of soldiers, who founded Radium Institute in Paris and in 1932 the Radium Institute in Warsaw, at present The Maria Skłodowska-Curie Institute of Oncology.

4. KITCHEN: FOOD IRRADIATION

Food spoils and loses its nutritional value not only due to the biological deterioration processes but also due to the activity of insects and microorganisms such as bacteria, molds or yeasts. The metabolism of microbes accelerates food spoilage, decreasing its shelf-life and hence causing economic losses. Even more importantly for humans, the intestinal bacterial infections may cause serious illnesses and even death. According to the Center for Disease Control more than 300 000 persons require hospitalization and about 5000 die annually in USA alone due to the pathogen contaminated food [14]. The most dangerous bacteria leading to serious infections are *E. coli* and *salmonella*. It is estimated that more than 60% of chicken sold in Europe or in the USA are contaminated with *salmonella* [15]. In general about 48 millions of Americans get sick from infected food each year and as much as 38 million out of these cases are caused by unknown pathogens [16]. The above examples indicate that even in highly developed countries, the reduction of the number of microorganisms in human foods and its preservation from spoilage is of crucial importance, especially if this could be performed without application of chemicals harmful to health and to the environment. This can be achieved by means of nuclear radiation, which may decrease the number of microorganisms and their spores, slow down ripening of fruits and inhibit

sprouting of vegetables. The first investigations of food irradiation with X-rays were conducted in the end of 19th century and interestingly first USA and British patents for the use of ionizing radiation to kill bacteria were issued already in 1905 [17]. Nowadays more than forty countries (including Poland) use irradiation for the preservation of food. The irradiation is carried out remotely without any direct contact of food with the radioactive source. It is mostly performed by means of gamma quanta emitted from cobalt or cesium sources. ^{60}Co decays into an excited state of nickel (^{60}Ni), which subsequently de-excites by the emission of gamma quanta predominantly with energy of about 1.17 MeV or 1.33 MeV. In the case of cesium, an isotope of ^{137}Cs is used which decays to barium (^{137}Ba), which next emits gamma quantum with energy of about 0.66 MeV. Such energies are too small to induce nuclear reactions. However, in principle, gamma quantum with energy of 2.5 MeV emitted from ^{60}Co source with relative intensity of 2×10^{-8} may disintegrate the nucleus of deuterium whose abundance in natural hydrogen amounts to 1.5×10^{-4} ($\gamma + d \rightarrow p + n$), and whose binding energy is equal to about 2.26 MeV. Next, the neutron may activate nucleus of other atoms contained in food. However, taking into account (i) probability for such chain of reactions, (ii) small abundance and (iii) small fractional intensity for emission of such gamma quanta, a nuclear activation in food due to the irradiation from ^{60}Co may be safely neglected. Nuclear reactions in food may however be induced naturally by cosmic radiation or natural abundance of elements originating from decay chain of Thorium (^{232}Th) [16], e.g. by ^{208}Tl isotope of Thallium which emits gamma quanta with energy of 2.61 MeV. Thorium, for example, is contained naturally in Brazil nuts.

A degree of irradiation may be measured by energy absorbed in the material normalized to its mass. The absorbed dose defined like this is expressed in grays ($\text{Gy} = \text{J/kg}$). A gamma quantum passing through matter may interact with an electron which absorbs part or whole of its energy. Next, the struck electron excites or ionizes atoms and molecules in its path. For a 1 MeV gamma quantum the number of ionized molecules is in the order of 10^5 . This causes breaking of chemical bonds and induces breaking of molecules, and as a consequence, injury to cells. The biological harm of irradiation depends, however, not only on the absorbed dose but also on the ionization density. Alpha particles, being about 8000 times more massive than electrons and possessing two times larger electric charge, deposit their whole energy on the few tens of micrometers (usually a few cells), whereas electrons with the same energy may traverse few millimeters depositing on average much less

energy in single cells and hence causing less biological harm. Therefore, in order to estimate biological damages caused by irradiation, an absorbed dose is corrected for the weighting factor depending on the radiation type. The resulting effective dose is expressed in sieverts (Sv). The weight is equal to 20 for alpha particles and 1 for electrons and gamma quanta. Hence, in case of gamma and beta radiation the value of an absorbed dose is equal to the equivalent dose ($1 \text{ Gy} = 1 \text{ Sv}$). The lethal dose for human beings amounts to about 3 Sv. This value is defined as a dose causing death of 50% of a given population within 30 days. In case of microorganisms such as bacteria the lethal dose is approximately 1000 times larger.

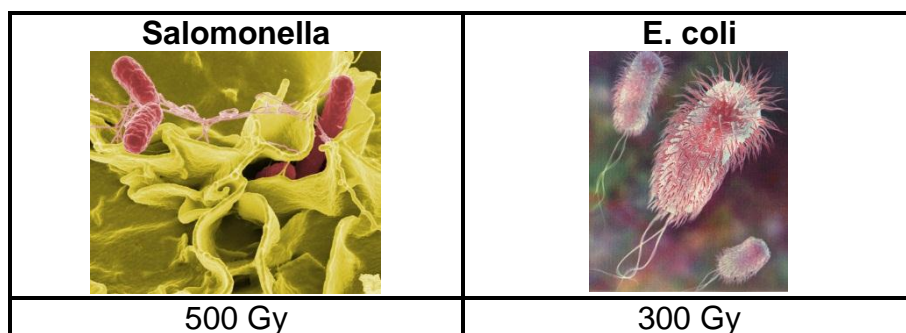

Fig. 7. Dose required to reduce the population by 90%. The pictures are taken from <http://pl.wikipedia.org/>.

A dose of irradiation has to be chosen such that most microorganisms contained in the food are killed. Values given in Fig. 7 imply that it should be on the order of 1000 Gy. Such a dose of radiation would reduce a population of salmonella by 99%, and E. coli by 99.9%.

It is important to mention that the nutritional value due to the content of protein, fat and sugar does not change under irradiation with such doses. This is because the amount of damage to a given molecule depends linearly not only on the value of the dose but it is also proportional to the number of atoms constituting the molecule [18]. The latter is much larger for DNA molecules than e.g. for sugar. Consequently irradiation with 1000 Gy, reducing the number of bacteria by 99%, decreases the content of sugar by only 0.0000001%. Vitamin losses are similar to other food preservation methods, such as canning and freezing.



Fig 8. Illustration of how the sprouting losses in stored potatoes can be prevented by irradiation with a dose of 200 Gy. In Japan potatoes have been irradiated industrially already since 1973. The figure is taken from [17].

Irradiation of food results not only in the reduction of microbes and their spores but also significantly extends the storage life of fruits and vegetables, preventing the emergence of fruit flies and sprouting (see Fig. 8). In order to inhibit sprouting a dose in the order of 100 Gy is sufficient.

Investigations of possible toxic effects of irradiated food (with doses of 59000 Gy) on the health of animals have been carried out for a long time. They were also carried out on groups of human volunteers [17]. So far to the knowledge of the author no negative influence has been proven.

The Food and Agriculture Organization of the United Nation (FAO), International Atomic Energy Agency (IAEA), World Health Organization (WHO) and, among others also the European Commission's Scientific Committee on Food have determined that irradiation of food with doses up to 10000 Gy is safe. At the same time they concluded that there is no scientific basis for limiting absorbed doses to the upper level of 10000 Gy as currently recommended [17]. Larger doses are used for food preservation for astronauts and in hospitals [18]. In the USA doses up to 30 000 Gy are allowed for the preservation of spices. 10000 Gy is not sufficient if sterilization is required and therefore doses of 35 000 Gy are used for sterilization of medical tools or for transplantation purposes [19]. Radiation doses of approximately 50 000 Gy would allow long term storage of food without refrigeration. A few examples of the effect of irradiation are given in Tab. 3.

Table 3. Examples of food irradiation applications. The table is taken from [17]

Food	Dose [Gy]	Benefit
Potatoes, onions, garlic, etc.	50 - 150	Sprout inhibition
Cereals, fruits, dried fish and meat, etc.	150 - 500	Insect disinfestation and parasite disinfection
Fresh fruits and vegetables.	250 - 1000	Delay of physiological processes (e.g. ripening)
Fresh fish, strawberries, mushrooms etc.	1000 - 3000	Extension of shelf-life
Fresh and frozen seafood, raw or frozen poultry and meat etc.	1000 - 7000	Elimination of spoilage and pathogenic microorganisms
Grapes (increasing juice yield), dehydrated vegetables (reduced cooking time).	2000 - 7000	Improving technological properties of food
Meat, poultry, seafood, prepared food, sterilized hospital diets.	30000 - 50000	Industrial sterilization (in combination with mild heat)
Spices, enzyme preparations, natural gum, etc.	10000 - 50000	Decontamination of certain food additives and ingredients

ACKNOWLEDGEMENTS

The author feels honored by the possibility to contribute to the Maria Curie-Skłodowska Symposium at the Maria Curie-Skłodowska University, and acknowledges very much the invitation from Prof. Karol Izydor Wysokiński and Prof. S. Zbigniew Korczak and their warm hospitality in Lublin. The author is also grateful to Mgr inż. M. Zieliński for help in preparation of figures and to D. Coderre for corrections of the text.

REFERENCES

- [1] S. Quinn, *Maria Curie: a life*. London: Heinemann, 1995 (Polish translation by A. Szymońska, Prószyński i S-ka, Warsaw 1997).
- [2] R.F. Mould, *The British Journal of Radiology*, **71**, 1229 (1998)
- [3] K. Kabzińska, M. H. Malewicz, J. Piskurewicz, J. Róziewicz, *Korespondencja Polska Marii Skłodowskiej-Curie*, IHN PAN, Warsaw (1994).
- [4] B. C. Maglich, *AIP Conf. Proc.* **796**, 431 (2005).
- [5] T. Gozani, D. Strellis, *Nucl. Instr. & Meth.* **B 261**, 311 (2007)
- [6] J. L. Humm, A. Rosenfeld, A. Del Guerra, *European Journal of Nuclear Medicine and Molecular Imaging* **30**, 1574 (2003)
- [7] Jerzy Dryzek „Wstęp do spektroskopii anihilacji pozytonów w ciele stałym”, Jagiellonian University Press, Cracow (1997).
- [8] M. Conti, *Physica Medica*, **25**, 1(2009)
- [9] T. Sugitate et al., *Nucl. Instr. & Meth.* **A 249** (1986) 354
- [10] P. Moskal, Patent Application No: P 388 555 [WIPO ST 10/C PL388555] (2009), PCT/PL2010/00062 (2010).
- [11] P. Moskal et al., *Bio-Algorithms and Med-Systems* **14** (2011), in print.
- [12] B.C. Maglich, *Birth of „Atometry” – Particle Physics Applied To Saving Human Lives*, presentation at conference LEAP 2005, Bonn-Jülich, Germany (<http://www.fz-juelich.de/leap05/talks>)
- [13] B. Maglich et al., *Proceedings of ASME 2010 First Global Congress on Nano-Engineering for Medicine and Biology NEMB 2010* and notes available at: <http://www.calseco.com/>
- [14] J. Scott, S. Pillai, *Technology* **58** (2004) 48
- [15] Elsevier Business Information, *Preserving food by irradiation*, LabPlus International, **14** (2000)
- [16] M. Ragheb, *Food preservation by irradiation*, <https://netfiles.uiuc.edu/mragheb/www/NPRE%20402%20ME%20405%20Nuclear%20Power%20Engineering/Food%20Preservation%20by%20Radiation.pdf>
- [17] International Consulting Group on Food Irradiation, *Facts about food irradiation*, <http://www.physics.isu.edu/radinf/food.htm>
- [18] A. Dancewicz, *PTJ* **43**, 10 (2000)
- [19] W. Stachowicz, A. Kamiński, J. Michalik, *PTJ* **50**, 9 (2007)
